

dacor[®]

User Manual

Electric Cooktop

DTI36M977BB

DTI30M977BB



Contents

Regulatory Notice	5
--------------------------	----------

Important safety instruction	8
-------------------------------------	----------

What you need to know about safety instructions	8
State of California proposition 65 warning (US only)	9
For your safety	9
Surface cooking units	10
Electrical safety	12
Child safety	12
Ventilating hood	13
Glass/ceramic cooking surfaces	13
Critical installation warnings	14
Critical usage warning	15
Usage cautions	17
Critical cleaning warnings	18

Before you start	19
-------------------------	-----------

Cooktop at a glance	20
Residual heat indicator	22
Cooking areas	22
First-time use	23
Griddle (Flex Zone)	26
Touch-enabled screen	27
Cookware	28
Energy saving tips	32
Settings	33

Operations	34
-------------------	-----------

Control panel	34
Timer	39
Guided Cooking	42



Special features	51
Virtual flame technology	51
Flex Zone	52
Power Boost	54
Power management	54
Child Lock	55
Temperature detection	55
Maintenance	56
Cleaning	56
Cooktop surface	56
Surface protection	58
Cooktop sealing	59
Troubleshooting	60
Operating noises	60
Checkpoints	60
Information codes	63
Warranty and Service	64
Warranty	64



To Our Valued Customer:

Congratulations on your purchase of the very latest in Dacor® products! Our unique combination of features, style and performance make us The Life of the Kitchen™, and a great addition to your home.

In order to familiarize yourself with the controls, functions and full potential of your new Dacor Appliance, read this use and care manual thoroughly, beginning with the **Important Safety Instructions** section.

All Dacor appliances are designed and manufactured with quality and pride, while working within the framework of our company value. Should you ever experience a problem with your product, please first check the Troubleshooting section of this manual for guidance. It provides useful suggestions and remedies prior to calling for service.

Valuable customer input helps us to continuously improve our products and services, so please feel free to contact our Customer Service Team for assistance with any of your product support needs.

Dacor Customer Service Team
14425 Clark Avenue
City of Industry, CA 91745

Telephone: (800) 793-0093

Fax: (626) 403-3130

Hours of Operation: Monday through Friday 6:00 A.M. to 5:00 P.M. Pacific Time

Website: www.Dacor.com

Thank you for choosing Dacor for your home. We are a company built by families for families, and we are dedicated to serving yours. We are confident that your new Dacor product will deliver a high level of performance and enjoyment for many years to come.

Sincerely,

The Dacor Customer Service Team

Regulatory Notice

1. FCC Notice

CAUTION

FCC CAUTION: Any changes or modifications not expressly approved by the party responsible for compliance could void the user's authority to operate the equipment.

This device complies with Part 15 of FCC Rules. Operation is Subject to following two conditions:

- 1) This device may not cause harmful interference, and
- 2) This device must accept any interference received including interference that cause undesired operation.

For products sold in the US and Canadian markets, only channels 1~11 are available. You cannot select other channels.

FCC STATEMENT:

This equipment has been tested and found to comply within the limits for a Class B digital device, pursuant to part 15 of the FCC Rules. These limits are designed to provide reasonable protection against harmful interference in a residential installation.

This equipment generates, uses, and can radiate radio frequency energy and, if not installed and used in accordance with the instructions, may cause harmful interference to radio communications. However, there is no guarantee that interference will not occur in a particular installation. If this equipment does cause harmful interference to radio or television reception, which can be determined by turning the equipment off and on, the user is encouraged to try to correct the interference by one or more of the following measures:

- Reorienting or relocating the receiving antenna
- Increasing the separation between the equipment and receiver

Regulatory Notice

- Connecting the equipment to an outlet that is on a different circuit than the radio or TV.
- Consulting the dealer or an experienced radio/TV technician for help.

FCC RADIATION EXPOSURE STATEMENT:

This equipment complies with FCC radiation exposure limits set forth for an uncontrolled environment. This equipment should be installed and operated so there is at least 8 inches (20 cm) between the radiator and your body. This device and its antenna(s) must not be co-located or operated in conjunction with any other antenna or transmitter.

2. IC Notice

The term “IC” before the radio certification number only signifies that Industry Canada technical specifications were met. Operation is subject to the following two conditions: (1) this device may not cause interference, and (2) this device must accept any interference, including interference that may cause undesired operation of the device.

This Class B digital apparatus complies with Canadian ICES-003. For products sold in the US and Canadian markets, only channels 1~11 are available. You cannot select other channels.

IC RADIATION EXPOSURE STATEMENT:

This equipment complies with IC RSS-102 radiation exposure limits set forth for an uncontrolled environment. This equipment should be installed and operated so there is at least 8 inches (20 cm) between the radiator and your body. This device and its antenna(s) must not be co-located or operated in conjunction with any other antenna or transmitter.

General safety instructions

This unit has been tested and found to comply with the limits for a class B digital device, pursuant to Part 18 of the FCC rules. These limits are designed to provide reasonable protection against harmful interference in a residential installation. This unit generates, uses and can radiate radio frequency energy and, if not installed and used in accordance with the instructions, may cause harmful interference to radio communications.

However, there is no guarantee that interference will not occur in a particular installation. If this unit does cause harmful interference to radio or television reception, which can be determined by turning the unit off and on, the user is encouraged to try to correct the interference by one or more of the following measures:

- Reorienting or relocating the receiving antennae.
- Increasing the distance between the unit and receiver.
- Connecting the equipment to an outlet that is on a different circuit than the radio or TV.



Important safety instruction

Read and follow all instructions before using your cooktop to prevent the risk of fire, electric shock, personal injury, or damage when using the cooktop. This guide does not cover all possible conditions that may occur. Always contact your service agent or the manufacturer about problems that you do not understand.

What you need to know about safety instructions

Warnings and Important safety instructions in this manual do not cover all possible conditions and situations that may occur. It is your responsibility to use common sense, caution, and care when installing, maintaining, and operating your cooktop.

Important safety symbols and precautions

WARNING









Hazards or unsafe practices that may result in **severe personal injury or death**.

CAUTION

Hazards or unsafe practices that may result in **minor personal injury or property damage**.

CAUTION

To reduce the risk of fire, explosion, electric shock, or personal injury when using your cooktop, follow these basic safety precautions.

	Do NOT attempt.
	Do NOT disassemble.
	Do NOT touch.
	Follow directions explicitly.
	Unplug the power plug from the wall socket.
	Make sure the machine is grounded to prevent electric shock.
	Call a Dacor service center for help.
	Note

These warning signs are here to prevent injury to you and others.

Please follow them explicitly.

After reading this section, keep it in a safe place for future reference.

Important safety instruction







State of California proposition 65 warning (US only)

WARNING: This product contains chemicals known to the State of California to cause cancer and birth defects or other reproductive harm.

For your safety

When using electrical appliances, you should follow basic safety precautions, including the following:

CAUTION

- Use this appliance only for its intended purpose as described in this Owner's Manual.
- Potentially hot surfaces include cooktop, the cooktop facing, and areas near the cooktop.
-  User servicing - Do not repair or replace any part of the appliance unless specifically recommended in this manual. All other servicing should be referred to a qualified technician.
- 
 - Do not store items of interest to children in cabinets above the cooktop surface. Children climbing on the cooktop to reach items could be seriously injured.
 - **Do not leave children alone.** Never leave children alone or unattended in an area where this appliance is in use. They should never be allowed to sit or stand on any part of the appliance.
 - **Never use your appliance for warming or heating the room.**
 - **Do not use water on grease fires.** Turn off the cooktop to avoid spreading the flames. Smother the fire or flames or use a dry chemical, baking soda, or foam-type extinguisher.
- 
 - Storage in or on the appliance. Do not store flammable materials near the surface units. Be sure all packing materials are removed from the appliance before operating it. Keep plastics, clothes, and paper away from parts of the appliance that may become hot.
 - **Wear proper apparel.** Never wear loose-fitting or hanging garments while using the appliance.
 - **Use only dry potholders.** Placing moist or damp potholders on hot surfaces may result in burns from steam. Do not let the potholder touch hot heating elements. Do not use a towel or other bulky cloth.
 - Teach children not to play with the controls or any other part of the cooktop.
-  Be sure your appliance is properly installed and grounded by a qualified technician.



Important safety instruction

- ☐ Avoid scratching or striking the cooktop. Doing so may lead to glass breakage. Do not cook on a cooktop with broken glass. Shock, fire, or cuts may occur.
- ★
 - For your safety, do not use high-pressure water cleaners or steam jet cleaners to clean any part of the cooktop.
 - If the power cord is damaged, it must be replaced by the manufacturer, its service agent, or similarly qualified persons to avoid creating a hazard.
 - The appliance is not intended for use by persons (including children) with reduced physical, sensory or mental capabilities, or lack of experience and knowledge, unless they have been given supervision or instruction concerning use of the appliance by a person responsible for their safety.
 - Do not lean on the cooktop as you may turn the control knobs inadvertently.

Surface cooking units

- ☐
 - Never leave surface units unattended at high heat settings. Boilovers cause smoking and greasy spillovers that may ignite.
 - Protective Liners - Do not use aluminum foil to line surface unit drip bowls or oven bottoms, except as suggested in the manual. Improper installation of these liners may result in a risk of electric shock or fire.
 - **Do not lift the cooktop.** Lifting the cooktop can damage the cooktop and cause the cooktop to malfunction.
 - Never use the glass cooktop surface as a cutting board.
 - Metallic objects such as knives, forks, spoons and lids should not be placed on the cooking surface since they can get hot.
 - After use, switch off the cooking surface by its control and do not rely on the pan detector.
 - **CAUTION:** The cooking process has to be supervised. A short term cooking process has to be supervised continuously.
 - **WARNING:** Unattended cooking on the cooking surface with fat or oil can be dangerous and may result in a fire.



- ★ • **Use care when touching the cooktop.** The glass surface of the cooktop will retain heat after the controls have been turned off.
- **Use proper pan sizes.** This appliance is equipped with surface units of different size. Select pots and pans that have flat bottoms large enough to cover the surface area of the heating element. Using undersized cookware will expose a portion of the heating element to direct contact and may result in the ignition of clothing. Matching the size of the pot or pan to the burner will also improve efficiency.
- **Cookware Handles Should Be Turned Inward and Not Extend Over Adjacent Surface Units** – To reduce the risk of burns, ignition of flammable materials, or spillage due to unintentional contact with cookware, position cookware handles so that they are turned inward and do not extend over adjacent surface units.
- **Glazed cookware.** Only certain types of glass, glass/ceramic, ceramic, earthenware, or other glazed cookware can be used for rangetop service without breaking due to sudden changes in temperature.
- Always turn the surface units off before removing cookware.
- Keep an eye on foods being fried at high or medium high heat settings.
- ☐ • To avoid oil spillover and fire, use a minimum amount of oil when shallow pan-frying and avoid cooking frozen foods that have excessive amounts of ice.
- **Do not operate the cooktop without cookware.** If the cooktop operates without cookware, the control knobs will become hot.
- ★ • Do not move the container and bowl in a horizontal position on cooktop surface.
- **Be careful when placing spoons or other stirring utensils on the glass cooktop surface when it is in use.** They may become hot and could cause burns.
- **Cleaning.** Read and follow all instructions and warnings on the cleaning cream labels.
- Be sure you know which control knob operates each surface unit. Make sure you have turned on the correct surface unit.
- When preparing flaming foods under the hood, turn the fan on.
- **Do not store heavy items above the cooktop surface that could fall and damage it.**
- **Do not Use Decorative Surface Element Covers** – If an element is accidentally turned on, the decorative cover will become hot and possibly melt. Burns will occur if the hot covers are touched. Damage may also be done to the cooktop.

Important safety instruction

Electrical safety

Use factory installed flexible cord to connect to power supply only, do not use power supply cord kit.

- ☑ • The cooktop should be serviced only by qualified service personnel. Repairs carried out by unqualified individuals may cause injury or a serious malfunction. If your appliance is in need of repair, contact a Dacor authorized service center. Failure to follow these instructions may result in damage and void the warranty.
- Flush - mounted appliances may be operated only after they have been installed in cabinets and workplaces that conform to the relevant standards. This ensures that the appliances are installed in compliance with the appropriate safety standards.
- If your appliance malfunctions or if fractures, cracks, or splits appear:
 - switch off all cooking zones
 - unplug the cooktop from the AC wall outlet
 - contact your local Dacor service center.

WARNING

If the surface is cracked, switch off and unplug the appliance to avoid the possibility of electrical shock. Do not use your cooktop until the glass surface has been replaced.

Child safety

WARNING

- This appliance is not intended for use by young children or infirm persons without the adequate supervision of a responsible adult.
- Young children should be supervised to ensure that they do not play with the appliance.
- The cooking zones will become hot when you cook. To keep small children from being burned, always keep them away from the appliance while you are cooking.

WARNING

Accessible parts may become hot during use. To avoid burns, young children should be kept away.

Ventilating hood

- ★ • Clean ventilating hoods frequently. Do not let grease accumulate on the hood or filter.
- When flaming foods under the hood, turn the fan on.





Glass/ceramic cooking surfaces

- ☐ • **DO NOT TOUCH SURFACE UNITS OR AREAS NEAR UNITS.**
Surface units may be hot even though they are dark in color. Areas near surface units may become hot enough to cause burns. During and after use, do not touch, or let clothing or other flammable materials contact the surface units or areas near the units until they have had sufficient time to cool. Among these areas are the cook-top and the facing of the cooktop.
- **Do not cook on a broken cooktop.** If the cooktop should break, cleaning solutions and spillovers may penetrate the broken cooktop and create a risk of electric shock. If your cooktop breaks, contact an authorized Dacor service center immediately.
- ★ • **Clean the cooktop with caution.** If a wet sponge or cloth is used to wipe spills on a hot cooking area, be careful to avoid steam burns. Some cleaners can produce noxious fumes if applied to a hot surface.

Important safety instruction





Critical installation warnings

WARNING

-  • This appliance must be installed by a qualified technician or service company.
 - Failing to have a qualified technician install the cooktop may result in electric shock, fire, an explosion, problems with the product, or injury.
- Unpack the cooktop, remove all packaging material and examine the cooktop for any damage such as dents. If there is any damage, do not operate the cooktop and notify your dealer immediately.
- Keep all packaging materials out of the reach of children. Children may use them for play and injure themselves.
- Install the cooktop on a sturdy, level cabinet that can support its weight.
 - Failing to do so may result in problems with the cooktop.
-  • This appliance must be properly grounded.
- Do not ground the appliance to a gas pipe, plastic water pipe, or telephone line.
 - This may result in electric shock, fire, an explosion, or problems with the product.
- Do not cut or remove the grounding prong from the power cord under any circumstances.
- Connect the cooktop to a circuit that provides the correct amperage.
-  • Do not install this appliance in a humid, oily or dusty location, or in a location exposed to direct sunlight or water (rain drops).
 - This may result in electric shock or fire.
- Do not use a damaged power cord or loose wall socket.
 - This may result in electric shock or fire.
- Do not pull or bend the power cord excessively.
- Do not twist or tie the power cord.
- Do not hook the power cord over a metal object, place a heavy object on the power cord, or insert the power cord between objects.
 - This may result in electric shock or fire.
-  If the power cord is damaged, contact your nearest Dacor service center.

Critical usage warning

CAUTION

-  • If the appliance is flooded by any liquid, please contact your nearest Dacor service center. Failing to do so may result in electric shock or fire.
- If the appliance produces a strange noise, a burning smell, or smoke, unplug the power plug immediately and contact your nearest Dacor service center.
 - Failing to do so may result in electric shock or fire.
- In the event of a gas leak (such as propane gas, LP gas, etc.), ventilate the area immediately. Do not touch the power cord. Do not touch the appliance.
 - A spark may result in an explosion or fire.
- Take care not to contact the cooktop surface with your body while cooking or just after cooking.
 - Failing to do so may result in burns.
- Always observe safety precautions when using your cooktop. Never try to repair the cooktop on your own - there is dangerous voltage inside. If the cooktop needs to be repaired, contact an authorized Dacor service center near you.
- If you use the appliance when it is contaminated by foreign substances such as food waste, it may result in a problem with the appliance.
-  • Do not attempt to repair, disassemble, or modify the appliance yourself.
 - Since a high voltage current enters the product chassis, it may result in electric shock or fire.
 - When a repair is needed, contact your nearest Dacor service center.
-  • If any foreign substance such as water has entered the appliance, contact your nearest Dacor service center.
 - Failing to do so may result in electric shock or fire.
-  • Do not touch the power cord with wet hands.
 - This may result in electric shock.
- Do not turn the appliance off while an operation is in progress.
 - This may cause a spark and result in electric shock or fire.
- Keep all packaging materials well out of the reach of children, as packaging materials can be dangerous to children.
 - If a child places a plastic bag over his or her head, the child can suffocate.



Important safety instruction

- ☐ • Do not let children or any person with reduced physical, sensory, or mental capabilities use this appliance unsupervised.
- Keep pets away from the appliance because pets may step on the controls of the appliance, causing a malfunction.
- Make sure that the appliance's controls and cooking areas are out of the reach of children.
 - Failing to do so may result in electric shock, burns, or injury.
- Do not use or place flammable sprays or objects near the cooktop.
 - Flammable items or sprays can cause fires or an explosion.
- Do not insert fingers, foreign substances, or metal objects such as pins or needles into inlets, outlets, or holes. If foreign substances are inserted into any of these holes, contact your product provider or nearest Dacor service center.
- Never use this appliance for purposes other than cooking.
 - Using the appliance for any purpose other than cooking may result in fire.
- Never heat plastic or paper containers and do not use them for cooking.
 - Failing to do so may result in a fire.
- Do not heat food wrapped in paper from magazines, newspapers, etc.
 - This may result in a fire.
- Do not hold food in your bare hands during or immediately after cooking.
 - Use cooking gloves. The food may be very hot and you could burn yourself.
 - As the handle and cooktop surfaces may be hot enough to cause burns after cooking, use cooking gloves to protect your hands from burns.



Usage cautions

CAUTION

-  • If the surface is cracked, turn the appliance off.
 - Failing to do so may result in electric shock.
- Dishes and containers can become hot. Handle with care.
- Hot foods and steam can cause burns. Carefully remove container coverings, directing the steam away from your hands and face.
- Remove lids from baby food jars before heating. After heating baby food, stir well to distribute the heat evenly.

Always test the temperature by tasting before feeding the baby. The glass jar or the surface of the food may appear to be cooler than the interior, which can be hot enough to burn an infant's mouth.
- Take care as beverages or food may be very hot after heating.
 - Especially when feeding a child, make sure that the food or beverage has cooled sufficiently.
- Take care when heating liquids such as water or other beverages.
 - Make sure to stir during or after cooking.
 - Avoid using a slippery container with a narrow neck.
 - Wait at least 30 seconds after heating before removing the heated liquid.
 - Failing to do so may result in an abrupt overflow of the contents and cause burns.
-  • Do not stand on top of the appliance or place objects (such as laundry, lighted candles, lighted cigarettes, dishes, chemicals, metal objects, etc.) on the appliance.
 - This may result in electric shock, fire, problems with the product, or injury.
- Do not operate the appliance with wet hands.
 - This may result in electric shock.
- Do not spray volatile substances such as insecticide onto the surface of the appliance.
 - As well as being harmful to humans, it may also result in electric shock, fire, or problems with the product.

Important safety instruction

- ☐ • Do not put your face or body close to the appliance while cooking.
 - Take care that children do not come too close to the appliance.
- Failing to do so may result in children burning themselves. Do not scratch the glass of the cooktop with a sharp object.
 - This may result in the glass being damaged or broken.
- Do not store anything directly on top of the appliance when it is in operation.
- Do not over-heat food.
 - Overheating food may result in a fire.

Critical cleaning warnings

CAUTION

- ★ • Do not clean the appliance by spraying water directly on to it.
- Do not use benzene, thinner, or alcohol to clean the appliance.
 - This may result in discoloration, deformation, damage, electric shock, or fire.
- Take care not to hurt yourself when cleaning the appliance (externally or internally).
 - You may hurt yourself on the sharp edges of the appliance.
- Do not clean the appliance with a steam cleaner.
 - This may result in corrosion.
- Keep the cooktop surface clean. Food particles or spattered oils stuck to the cooktop surface can cause paint damage and reduce the efficiency of the cooktop.

Before you start

WARNING

- Do not use this induction cooktop to dry clothes.
- Do not store flammable materials such as aerosols and cleaning agents under the induction cooktop.
- Users with Pacemakers or Active Heart Implants must keep their upper body at least 1 ft. (30 cm) from the induction cooking zones that are turned on. For more information or questions, consult with your doctor or the manufacturer of your personal device.

CAUTION

- Do not touch the induction elements until they have cooled down. Otherwise, you can burn yourself.
- Do not touch the surface of the cooktop until it has cooled down. Otherwise, you can burn yourself.
- Immediately clean spills on the cooking area to prevent impurities from building up.
- If you have cabinet storage directly above the cooking surface, make sure that the items in the cabinet are safely stored in a heat-resistant area. Do not store flammable items such as volatile liquids, cleaners, or aerosol sprays.
- If the cooktop is installed above an oven, do not use the cooktop while the oven's self-cleaning function is on.

NOTE

After you have activated elements on the cooktop, the internal fan may rotate for cooling purposes. The fan activation time (10 to 20 minutes) may differ depending on the temperature of the internal sensor.

Before you start

Cooktop at a glance

36" full-touch cooktop

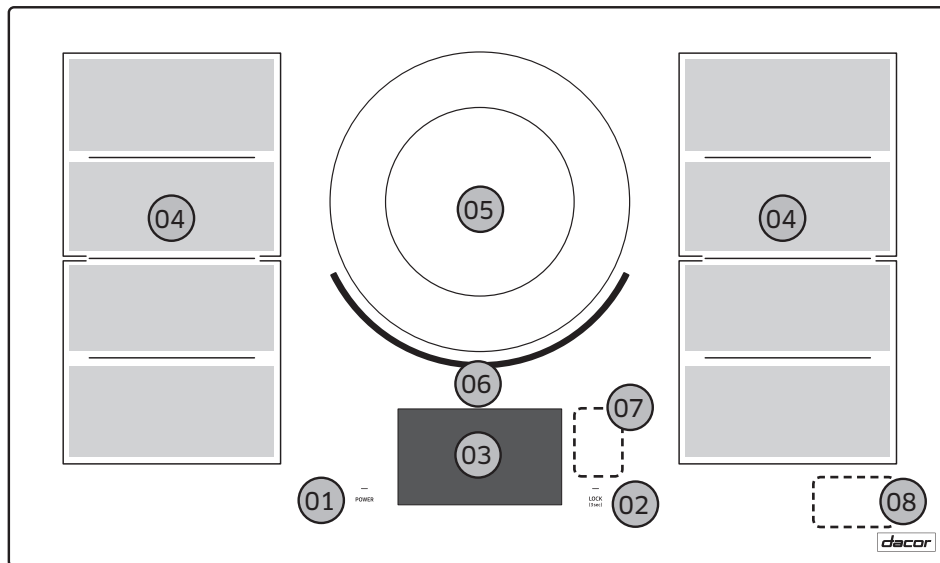

30" full-touch cooktop

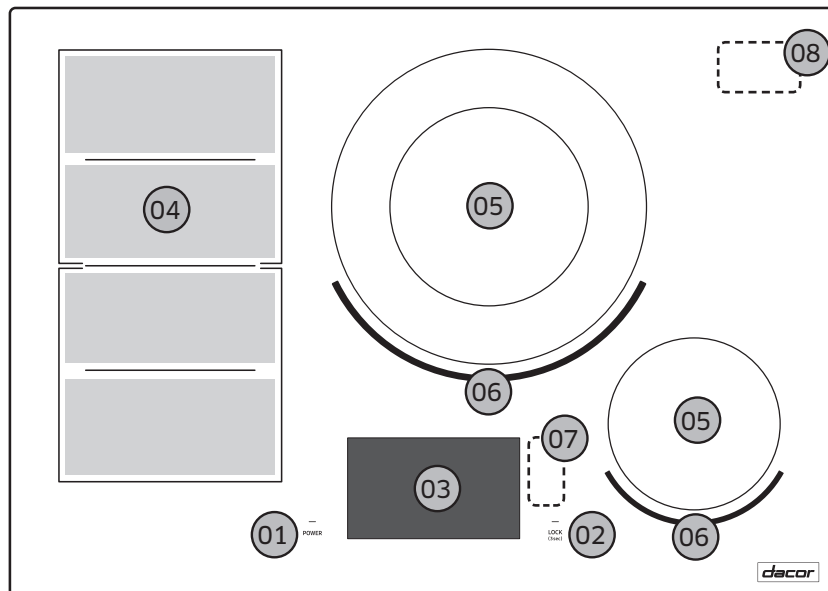

Before you start

01 POWER	Press to turn the cooktop on or off. When the cooktop is turned on, the corresponding indicator lights up.
02 LOCK	Press and hold to activate or deactivate the lock on the control panel. For more information, see the Child Lock section on page 55.
03 Display	7-inch touch-enabled screen.
04 Flex Zone	You can use the Flex Zone function to control two burners on either side (36" models) or the left side (30" models) as a single cooking zone.
05 Cooking zone	The cooking zone is identified by a permanent circle on the glass cooking surface. You can use the virtual flame technology.
06 Virtual Flame	The virtual flame technology creates the appearance of flames for visual references, which are not actual flares.
07 Wi-Fi communication area	The cooktop sends and receives Wi-Fi signals underneath this area.
08 Bluetooth communication area	The cooktop sends and receives Bluetooth signals underneath this area.

⚠ WARNING

- Do not put hot cookware on the control-panel area (01, 02, and 03). The LCD screen of this area can be damaged.
- Leave the Wi-Fi (07) and Bluetooth (08) areas empty at all times. Cookware or any other object may cause signal interference and consequent communication failure.

Before you start

Before you start

Residual heat indicator

When an individual cooking zone or the cooktop is turned off, the presence of residual heat is shown with an indicator on the corresponding cooking zone screen (see the table below). Even after the cooking zone has been switched off, the residual heat indicator will turn off only after the cooking zone has cooled down. You can use the residual heat for thawing or keeping food warm.

Indicator color

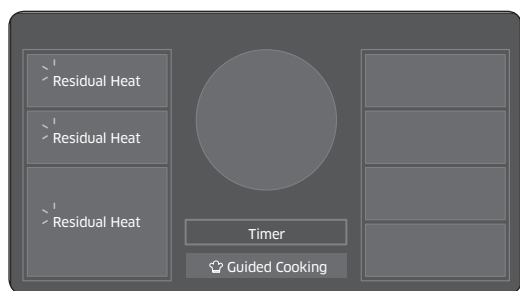

The residual heat indicator lights up as text on the corresponding cooking zone in the following color.

Red: when the cooktop surface is very hot.

White: when the cooktop surface is hot.

WARNING

- While the residual heat indicator stays lit, there is a risk of burns.
- If the power supply is interrupted for any reason, the heat indicator turns off. However, there is still a risk of burns. Always use caution especially when you are near the cooktop.

Cooking areas

- The cooking areas on your cooktop are identified by permanent circles on the glass cooking surface. For efficient cooking, fit cookware size to the burner size.
- The bottom of the pan must not be more than a half inch larger than the cooking area.
- For more information on selecting proper types and sizes of cookware, see the **Cookware** section on page 28.

First-time use

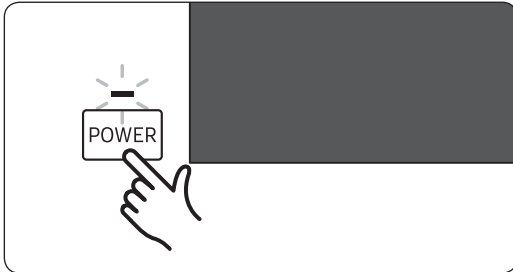

1. Press **POWER** to turn the cooktop on. The control panel turns on, and then displays the Home screen after a moment.

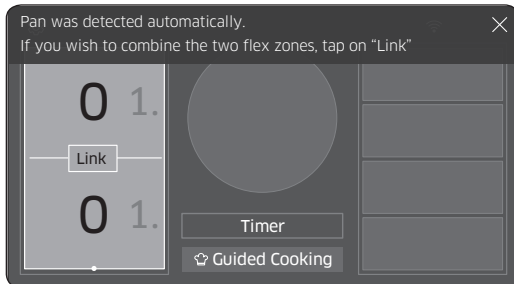

Auto pan detection:

With Flex Zone enabled, the Flex Zone indicator uses an automatic cookware detection to display the active zones.

- If inappropriate cookware is placed on the cooking zone, the indicator blinks. If the cookware is not removed, the cooking zone turns off.
 - Any of the synched burners may not operate properly with small cookware that slants to one burner slightly.
2. On the Home screen, tap or drag to select a cooking zone or burner.

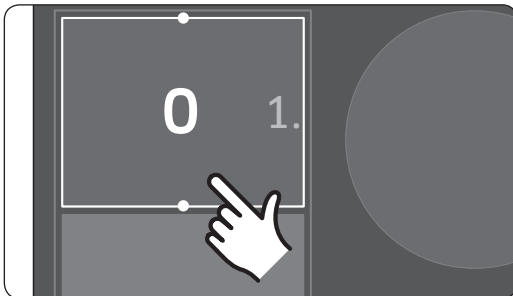

Before you start

Before you start

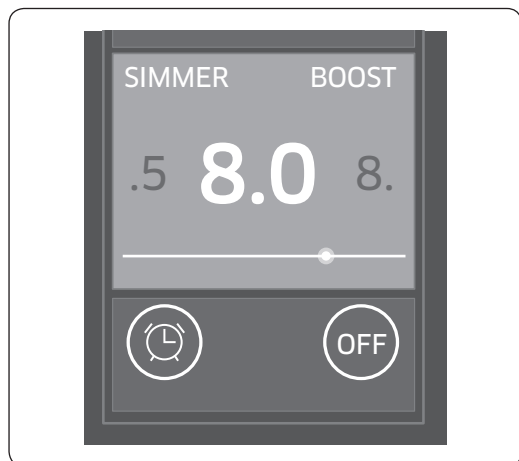

3. Put cookware on the burner, and then tap or drag the bar to select a power level. You can change the power level to 0, or between 1.0 and 9.0.
4. Tap an optional function (**SIMMER** or **BOOST**) if you want to use that function.
5. When complete, tap the set power level to start cooking or wait a few seconds and the burner starts automatically.

NOTE

If you do not set a power level after selecting a burner, the selected burner will be canceled automatically after a few seconds.

Initial cleaning

Before using the cooktop for the first time, clean the ceramic glass surface with a damp cloth and ceramic cooktop glass cleaner.

WARNING

Do not use caustic or abrasive cleaners. The surface can be damaged.

Safety shutoff

- If the cooktop overheats because of an abnormal operation, 'C1' will be displayed, and the cooktop will turn off.
- If unsuitable or excessively small-sized cookware is put on a cooking zone, or no cookware has been placed on a cooking zone, the cooktop will turn off automatically.
- If either of the above happen, clean the control panel and turn the cooktop on again.

To turn the cooktop off



To turn the cooktop off, press **POWER** again. After the cooktop is turned off, residual heat may remain with a corresponding indicator on the corresponding cooking zone. See page 22 for details.

Before you start

Recommended settings

The power levels in this table are general guidelines. The power settings required for various cooking methods can change, depending on the quality of the cookware being used and the type and amount of food being cooked.

Setting	Power level	Usage
HIGH/BOOST	8.0 - 9.0 (with Boost)	<ul style="list-style-type: none">To boil waterTo quickly start cooking foodTo quickly sear meat
MEDIUM HIGH	6.0 - 7.5	<ul style="list-style-type: none">To hold a rapid boilFor fat/pan/stir frying
MEDIUM	4.0 - 5.5	<ul style="list-style-type: none">To cook sauces and graviesTo steam vegetables
MEDIUM LOW	2.5 - 3.5	<ul style="list-style-type: none">To maintain a slow boilTo keep foods cooking, poaching, stewing
LOW	1.0 - 2.0 (for melting or simmering)	<ul style="list-style-type: none">To melt chocolate or butterTo keep foods warmTo simmer

Griddle (Flex Zone)







We recommend preheating the griddle before cooking food. See the table below for reference.

Cooking type	Setting
Pancakes	MEDIUM LOW
Fried eggs	MEDIUM LOW
French toast	MEDIUM LOW
Bacon, sausages	Select MEDIUM for desired brownness.
Hamburgers	Select MEDIUM HIGH for desired doneness.

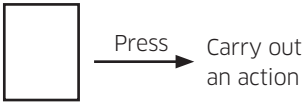
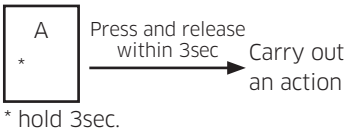
NOTE

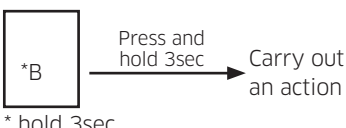
- The power settings indicated in the table above are provided only as guidelines for your reference.
- You will need to adjust the power settings according to specific cookware and foods.

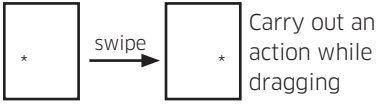
Touch-enabled screen

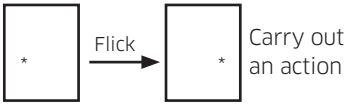
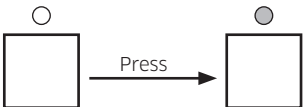
Method	Mark	Interaction	Description
Short press			Press and release a control to carry out an action. Use to power on or start an operation.
			
Long press			Press and hold a control to carry out an action. Mainly used to perform a secondary function. A corresponding message appears on the screen.
Drag/Swipe			Use to set the heating level of each cooking zone, or change the status (On/Off) in settings.
Flick			Use to open or move to the next Recipe page, or set the cooking time.
On/Off	-		Use to turn the indicator on or off, or display the setting value on the screen.

Before you start

Before you start

Cookware

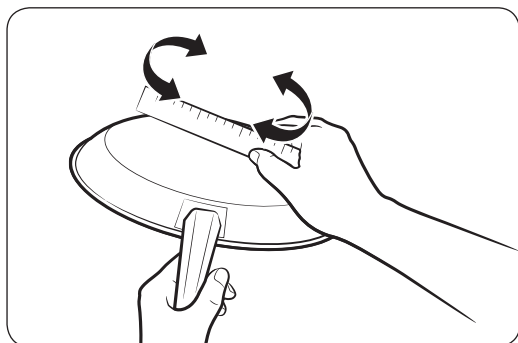

Use flat-bottomed cookware that completely contacts the entire cooking zone. Check for flatness by rotating a ruler across the bottom of the cookware. Be sure to follow all the recommendations for using cookware.

- Use cookware made with the correct material for induction cooking.
- Use quality cookware with heavier bottoms for better heat distribution. This gives best cooking results.
- Match the cookware size to the quantity of food being prepared.
- Do not let cookware boil dry. This may cause permanent damage in the form of breakage, fusion, or marring that can affect the ceramic cooktop. (This type of damage is not covered by your warranty).
- Do not use dirty cookware or cookware with heavy grease buildup. Always use cookware that is easy to clean after cooking.

CAUTION

- The cooking zones may appear cooled down after they have been turned off. However, the glass surface may be hot from residual heat transferred from the cookware. The risk of burns is still present.
- Do not touch hot cookware directly with your hands. Always use oven mitts or pot holders to protect your hands from burns.
- Do not slide cookware across the cooktop surface. Doing so may permanently damage the cooktop.

Cookware for induction cooking zones

The induction burner can only be turned on when cookware with a magnetic base is placed on one of the cooking zones. You can use the cookware identified as suitable below.

Material	Suitability
Steel, enameled steel	Yes
Cast iron	Yes
Stainless steel	Yes (if appropriately labelled by the manufacturer)
Aluminum, copper, brass	No
Glass, ceramic, porcelain	No

NOTE

- Cookware appropriate for induction cooking is labelled as suitable by the manufacturer.
- Certain cookware can make noises when being used on induction cooking zones. These noises do not indicate that the cooktop is malfunctioning and do not affect its operation in any way.
- Special stainless-steel cookware may not be suitable for induction cooking. Check if the base of the cookware is attracted by a magnet.

Other induction cookware

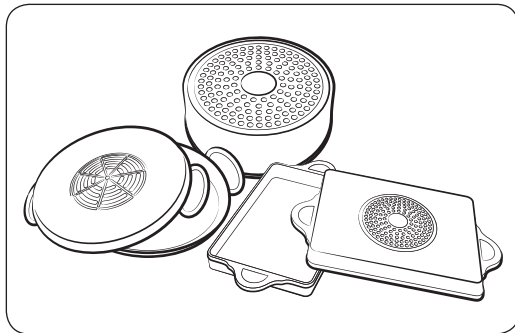

You can use induction cookware whose base is not solely ferromagnetic.



- When using large cookware with a smaller ferromagnetic element, only the ferromagnetic element heats up. Consequently, heat might not be uniformly distributed.
- Cookware with an aluminum base will reduce the ferromagnetic strength. This type of cookware may cause heat to be distributed less efficiently or may not be sensed by burners.
- For best results, use cookware whose ferromagnetic diameter match that of a burner. If the cookware is not sensed by the burner, try a smaller sized burner.

Before you start

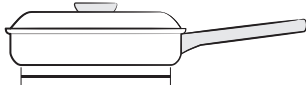
Correct positioning

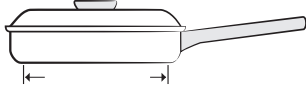
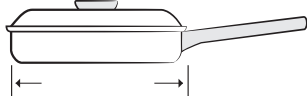
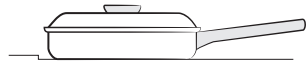
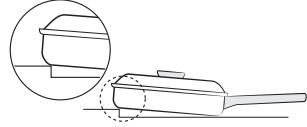
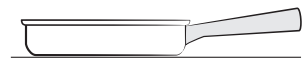
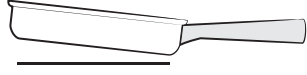
Correct	Incorrect
 <p>Flat-bottomed cookware and straight sides</p>	 <p>Cookware with curved or warped bottoms or sides</p>
 <p>The cookware meets or exceeds the recommended minimum size for the cooking zone.</p>	 <p>The cookware does not meet the minimum size required for the current cooking zone.</p>
 <p>The cookware rests completely on the cooktop surface.</p>	 <p>The cookware rests on the cooktop trim or does not rest completely on the cooktop surface.</p>
 <p>The cookware is properly balanced.</p>	 <p>The heavy handle causes the cookware to tilt.</p>

NOTE

Any one of the incorrect conditions listed above may be detected by the sensors located below the cooktop surface. If the cookware does not meet all of these conditions, one or more of the cooking zones will not heat.

Suitability test

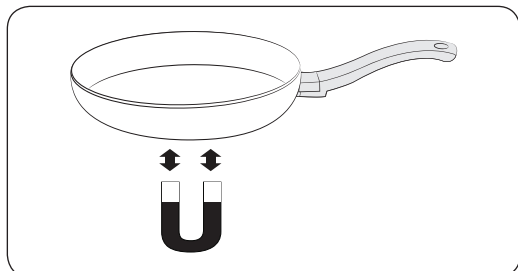

Cookware is suitable for induction cooking if a magnet sticks to the bottom of the cookware and the cookware is labelled as suitable by the cookware manufacturer.

- You can recognize good cookware by their bases. The base is supposed to be as thick and flat as possible.
- When buying new cookware, pay special attention to the diameter of the base. Manufacturers often give only the diameter of the upper rim.
- Do not use cookware which have damaged bases with rough edges or burrs. Damaged cookware can scratch the ceramic cooktop permanently if you slide them across the surface.
- When cold, cookware bases are normally bowed slightly inwards (concave). They must not be bent outwards (convex).
- If you want to use a special type of cookware, for example, a pressure cooker, a simmering pan, or a wok, please follow the manufacturer's instructions.

Cookware sizes for induction cooking zones

Induction cooking zones adapt automatically to the bottom size of the cookware up to a certain limit. However, the magnetic part of the bottom of the cookware must be longer than a minimum diameter depending upon the size of the cooking zone.

Cooking zone		Setting
Flex Zone	Front or rear Flex Zone	5.5 inches (140 mm)
	Flex Zone	9.4 inches (240 mm) for the longer side of an oval or fish kettle
Center cooking zone		6.3 inches (160 mm)
Right cooking zone (30" models only)		3.9 inches (100 mm)

Before you start

Energy saving tips

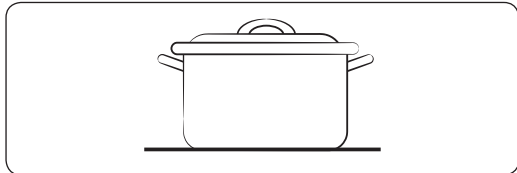

Correct

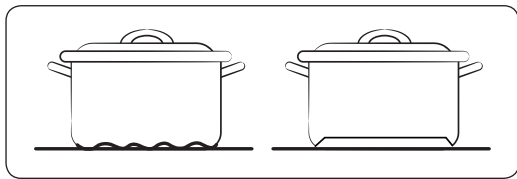

Incorrect

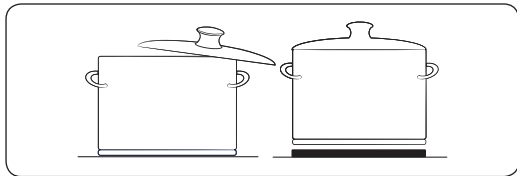

Incorrect

Follow these tips to save power consumption.

- Always put cookware on a cooking zone before you turn the corresponding burner on.
- Keep the cooking zones and cookware bases clean. Otherwise, more power will be consumed.
- Firmly close the cover of cookware if available. This will reduce power consumption.
- Turn the working burner off before the end of the cooking time. Use the residual heat to keep food warm.

Settings

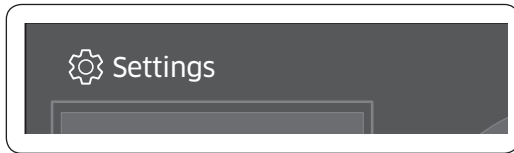

Tap the gear icon in the top left corner of the screen. Tap or drag to select or change settings.

Initial settings

When you turn the cooktop on for the first time, a welcome screen appears with the Dacor logo. Follow the onscreen instructions to complete the initial settings. You can change the initial settings later by accessing the Settings screen.

The initial settings consist of several steps. You are required to set a language. For detailed information about the settings of each step, see the corresponding section below.

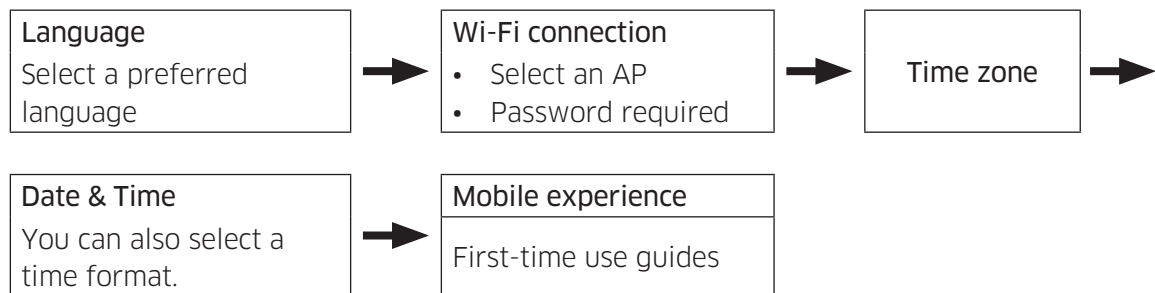

Before you start

Operations

Control panel

Intro screen



When you turn the cooktop on, the intro screen appears. Wait a moment until the Home screen appears.

Status bar

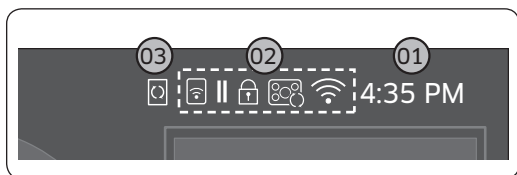

1. Current time: displays the current time.
2. Indicator area: see the table below.
3. Update indicator: This indicator turns on when a new software update is available.

Indicator area

Item	Icon	Descriptions
1. iQ Connect		When iQ Connect is connected successfully, this indicator lights up.
2. Hold		If you HOLD the operation of the cooktop, this indicator lights up.
3. Child Lock		When Child Lock is activated, this indicator lights up.
4. Hood connect		When Hood connect is connected successfully, this indicator lights up.
5. Wi-Fi sensitivity		Depending on the network conditions, this indicator lights up. The number of bars represents the strength of the Wi-Fi connection.
6. Remote management		If Remote management is activated for service purposes, this indicator lights up.

Home screen

Your cooktop has a total of 4-5 burners, depending on the model. The rounded burner or burners are designed for single cookware and can use the virtual flame technology.

- For 36" models, the other 4 burners on both sides of the cooktop surface can be used independently, or can be combined. If necessary, merge two burners on one side to form a larger burner.
- For 30" models, the other 2 burners on the left side of the cooktop surface can be used independently, or can be combined. If necessary, merge two burners on the left side to form a larger burner.

36" cooktop



Operations

30" cooktop



<p>01 Cooking zone</p>	<ul style="list-style-type: none"> • Tap to select a single cooking zone. • Tap again to make a multiple zone section. • Drag up or down to select multiple cooking zones. • When multiple cooking zones are selected, a popup message appears for your confirmation. To confirm, tap EXPAND.
<p>02 Context instruction</p>	<p>When you tap or drag to select a cooking zone, a context instruction appears. This instruction disappears after a cooking zone is selected.</p>
<p>03 Timer</p>	<p>Tap to open the Timer settings screen.</p>
<p>04 Guided cooking</p>	<p>Tap or flick up to open the Recipe screen.</p>
<p>05 Settings</p>	<p>Tap to enter the Settings screen.</p>

Power level

When a cooking zone is selected, the default power level is set to 0. To change the power level, swipe the number or drag the bar.

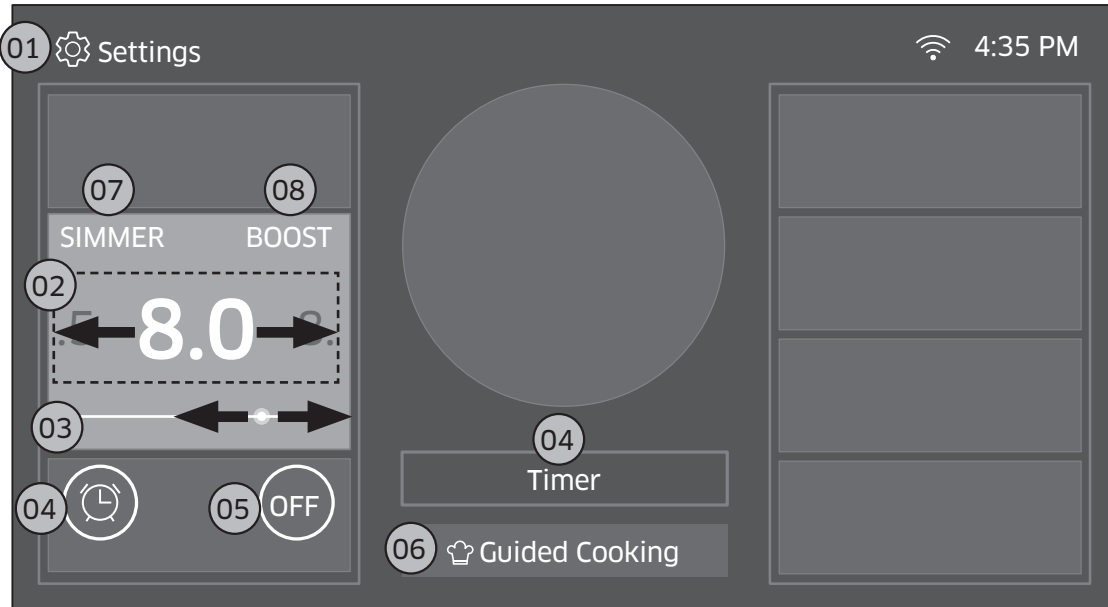

01 Settings	Tap to open the Settings menu screen.
02 Power level	Tap or drag the gauge bar to select a power level. You can change the power level to 0 or between 1.0 and 9.0.
03 Gauge bar	Use the gauge bar to quickly select a power level or skip to a certain level.
04 Timer	Tap Timer to set the timer. The Hold button appears after the timer is set. You can tap Hold to stop operating all active burners. See the Timer section on page 39.
05 Burner off	Tap to turn the selected burner off.
06 Guided Cooking	Tap to open the Guided Cooking screen.
07 Simmer/melt	Tap to enter Simmer or Melt mode.
08 Power boost	Tap to activate the Power Boost function.

Operations

Simmer or melt

For 36" models, all cooking zones support Simmer mode but not Melt mode. However, 30" models support Simmer mode for 3 burners, and Melt mode for the other 1 burner.

36" Simmer 5 ea

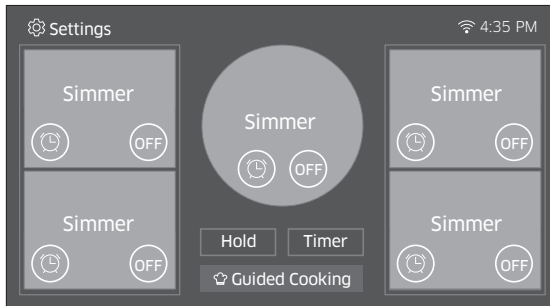

30" Simmer 3 ea and melt 1 ea

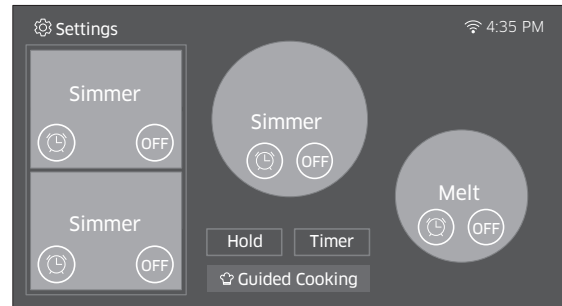

Timer

This cooktop provides 2 types of timers for different settings. The main timer is on the lower center of the control panel, and the zone-specific timer pops up when you tap the timer icon (🕒) for a specific cooking zone.

Main timer

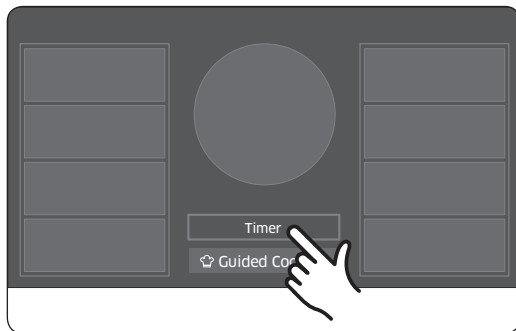

1. To use the main timer, tap **Timer** on the lower center of the control panel.

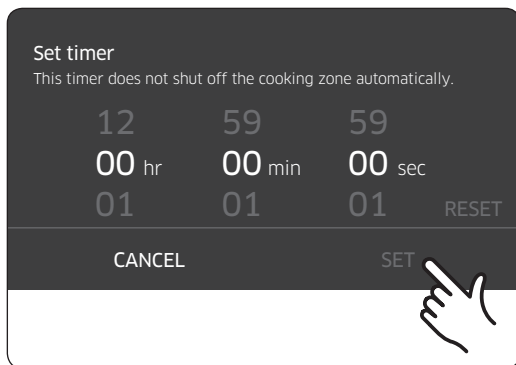

2. See the **Timer settings** section on page 41 to set the time. Then, tap **SET**.

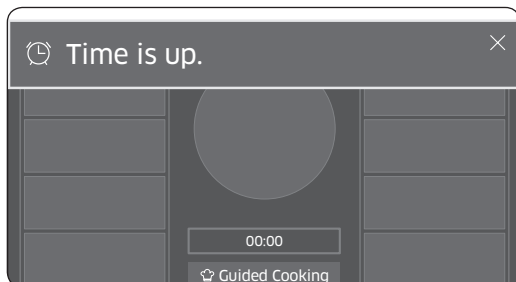

3. When the time is up, the Timer button changes to the remaining time ('00:00') that keeps blinking (and a melody sounds 4 times). Also, a notice pops up on the top and disappears in a moment.

Operations

Zone-specific timer



1. To use the zone-specific timer, tap the timer icon (⌚) for a specific cooking zone to display the timer screen.

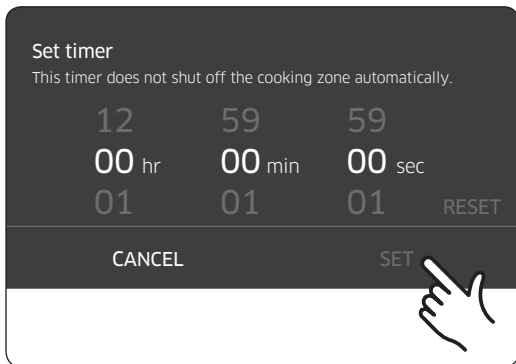

2. See the **Timer settings** section on page 41 to set the time. Then, tap **SET**.

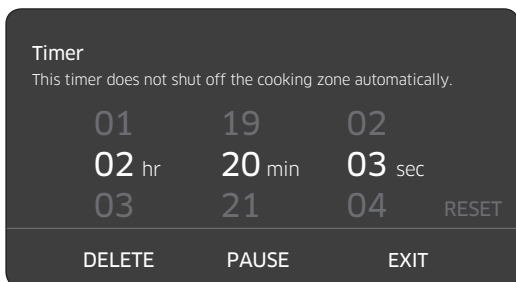

NOTE

If you have set the timer for multiple cooking zones, you can tap **Hold** to stop operating all active burners. To resume, tap **RESUME**.

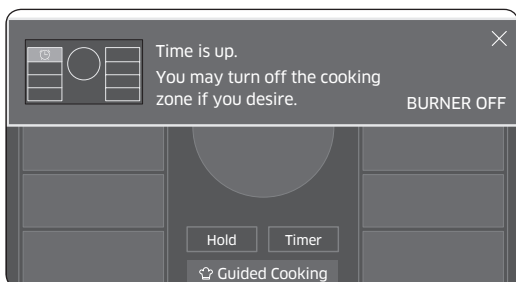

3. When the time is up, the Timer button changes to the remaining time ('00:00') that keeps blinking (and a melody sounds 4 times). Also, a notice pops up on the top and disappears in a moment.
4. To turn the burner off, tap **BURNER OFF** on the top notice.

Timer settings

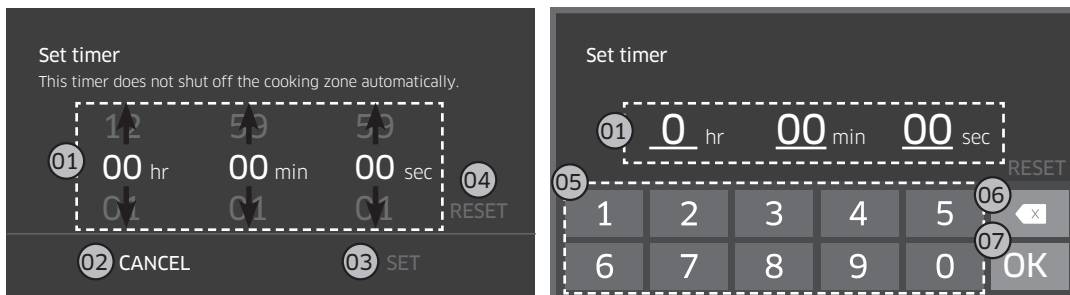

01 Time units	<ul style="list-style-type: none"> The default time is 0 hr 00 min 00 sec. Tap a digit to open the virtual number pad. Flick up or down to change the number. You can change the time up to 12 hr 59 min 59 sec.
02 Cancel	This works the same as the Exit button.
03 SET	Tap to start the timer and close the screen.
04 Reset	Tap to return the timer to 0 hr 00 min 00 sec.
05 Number pad	This is a virtual number pad.
06 Backspace	Tap to clear your changes.
07 OK	Tap to save your changes and return to the previous screen.

To change the timer settings

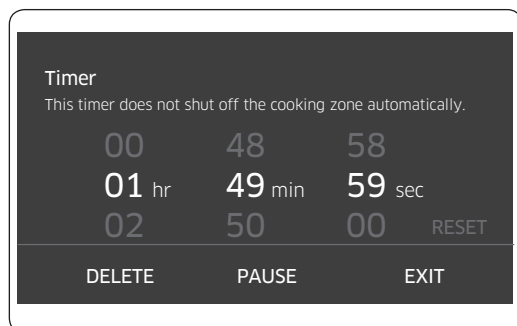

- Tap **DELETE** to cancel the timer.
- Tap **PAUSE** to stop the timer, and tap again to resume the timer.
- Tap **EXIT** to keep the timer and close the screen.

Operations

Guided Cooking

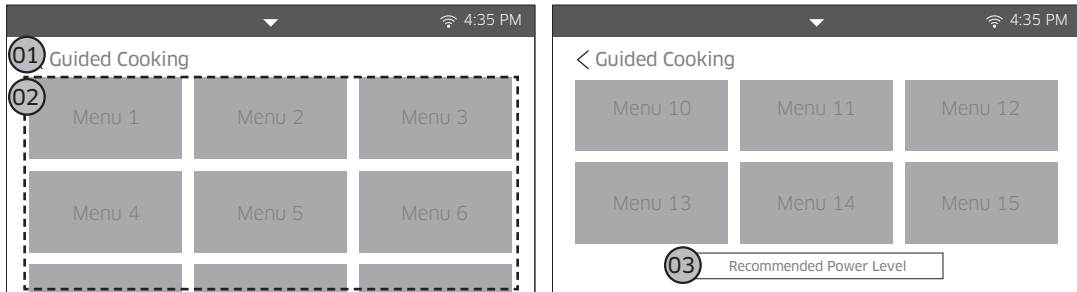

01 Title	Guided Cooking
02 Menu list	Menus available will be listed in a tile view.
03 Recommended power level	This is only for your reference. You can change the power level.

Introduction

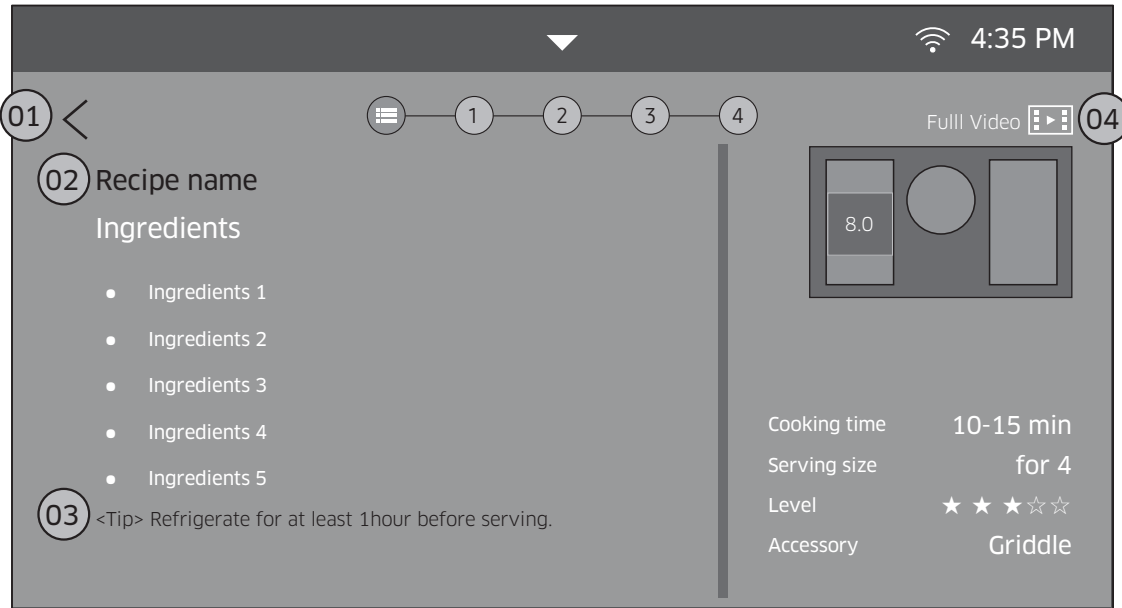

01 Back	Tap to return to the Guided Cooking menu list.
02 Recipe name	The current recipe name is displayed.
03 Tip	A recipe tip will be displayed at the bottom of the screen.
04 Video player	If a video reference is available with the current recipe, tap to play the video.

Operations

Details

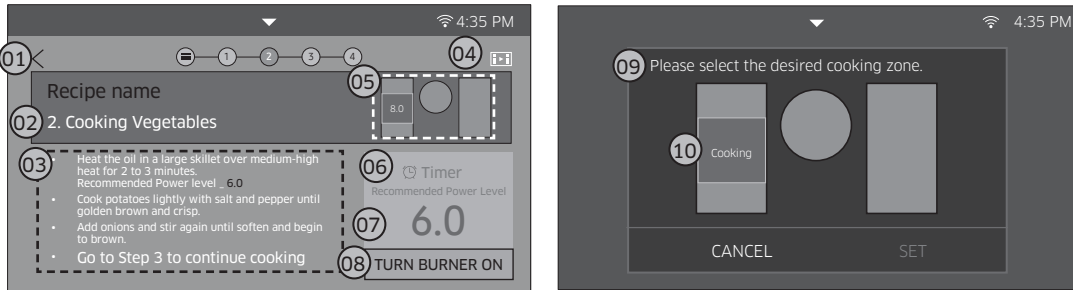

01 Progress bar	Tap a step to move to that step.
02 Step title	The title of the current step is displayed.
03 Detailed directions	Detailed directions of the recipe are displayed.
04 Video player	If a video reference is available with the current recipe, tap to play the video.
05 Monitoring	The status of active burners is displayed, and the current step is highlighted. If you want to cancel the active burner and return to the Home screen, tap this area.
06 Timer	The set timer is running. When the time is up, a beep will sound.
07 Power level	The recommended or current power level is displayed. If you want to change the power level, swipe this area.
08 Burner On/Off	Tap to turn the burner on, or tap again to turn it off.
09 Cooking zone	If no cooking zone is selected, a popup window appears.
10 Current cooking zone	The current cooking zone is highlighted.



Program overview

The cooktop provides 15 guided cooking programs for boiling, frying, grilling, stir frying, and simmering. These programs include their respective ingredients, cookware/ accessories, and the set power level and cooking time. You can find the recipe details on the screen or the mobile app.

No	Program	Cooking time	Serving size	Level	Cookware/ Accessory
1	French Toasts with Bacon and Maple Syrup	10-15 min	4	★★☆☆☆	Griddle
2	Manhattan Clam Chowder	40-50 min	4	★★☆☆☆	Pot + skillet
3	Rainbow Pasta Salad	20-30 min	4	★★☆☆☆	Pot
4	Lemon-Grilled Chicken Breasts	15-20 min	4	★★☆☆☆	Griddle
5	Grilled Salmon Steaks with Asparagus	15-20 min	4	★★☆☆☆	Griddle
6	Grilled Lime Shrimp Skewers	10-15 min	4	★★☆☆☆	Griddle
7	Hamburger Steaks with Onion Gravy	30-40 min	4	★★☆☆☆	Skillet
8	Chicken Cutlets	30-40 min	4	★★☆☆☆	Skillet
9	Beef Stew with Potatoes	100-120 min	4	★★☆☆☆	Pot
10	Beef Steak Fajitas	20-30 min	4	★★☆☆☆	Skillet
11	Shrimp with Tomatoes and Olives	10-20 min	4	★★☆☆☆	Skillet
12	Spanish Potato Omelet	30-40 min	4	★★☆☆☆	Skillet
13	Shrimp Fettuccine Alfredo	30-40 min	4	★★☆☆☆	Pot + skillet
14	Grilled Vegetables	10-20 min	4	★★☆☆☆	Griddle
15	Tomato Sauce with Fresh Tomatoes	40-50 min	4	★★☆☆☆	Pot

NOTE

You will need to adjust the power level or cooking time according to cookware and food items.



Operations

Wi-Fi

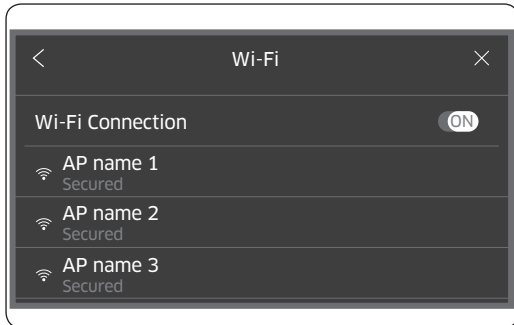

1. Tap to turn the Wi-Fi connection on. A list of available access points (AP) will be listed.
2. Select an AP.

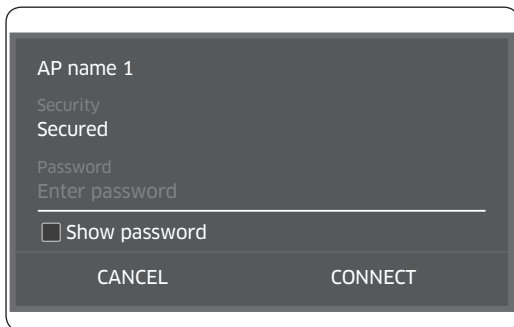

3. If this is the first time you have selected an AP, you will be prompted to enter a password. Provide a password, and then tap **CONNECT**. When the connection is made successfully, a confirmation message appears.

Encryption methods

WPA type: Enter 8 - 63 digits.

WEP type: Enter one of 5, 10, 13, and 26 digits.

NOTE

If the password you entered is not correct, the **CONNECT** button will be disabled.

Easy connection

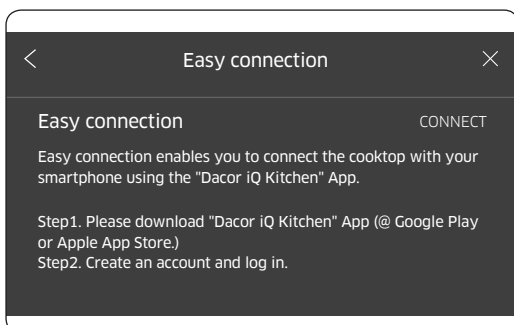

Easy connection allows you to easily connect the cooktop with your smartphone after you have installed the 'Dacor iQ Kitchen' app. Follow the onscreen instructions to activate Easy connection.

iQ connect

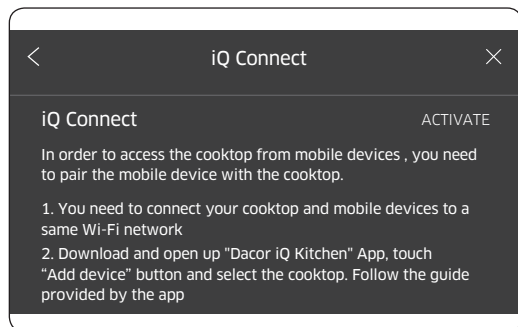

iQ Connect allows you to control the cooktop on your smartphone after you have installed the 'Dacor iQ Kitchen' app. You will be prompted to provide an authentication code that you receive from the app. Follow the onscreen instructions to activate iQ Connect.

Hood connect

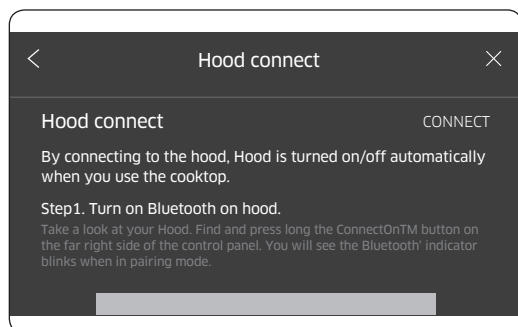

A hood can be paired with the cooktop. After the Bluetooth connection is made successfully, turn the cooktop on, and the hood will turn on automatically if ConnectOn™ of the hood is activated. Follow the onscreen instructions to activate Hood connect.

Remote management

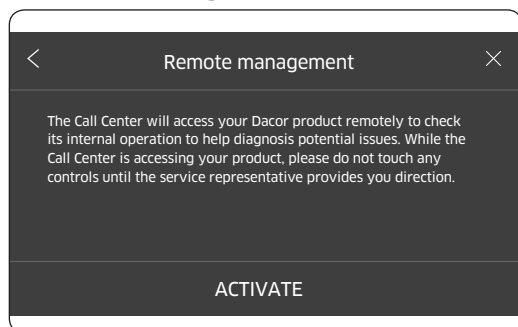

Allow Remote management to access your cooktop and check internal information of the cooktop. Remote management is used for troubleshooting purposes. If you encounter an issue to check, follow the onscreen instructions to activate Remote management.

Operations

Display

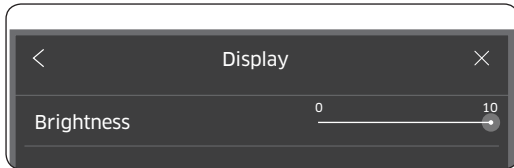

You can change the screen brightness. Tap or drag to change the value between 0 and 10.

Date & time

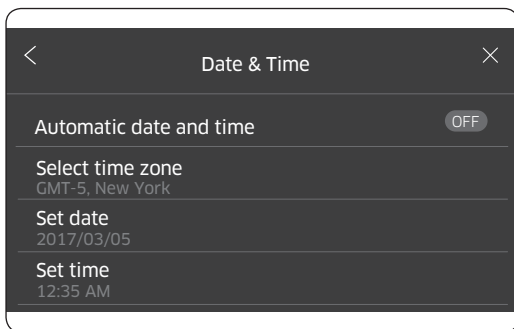

- Tap **Automatic date and time** to turn it on. The time zone information with the corresponding date and time will be synched with the timer server automatically.
- To change the time zone manually, tap **Select time zone**, and then choose a different time zone.
- To change the date, time, or time format manually, tap the corresponding menu, and then change the settings.
- When you complete the settings, tap **OK** to restart the system.

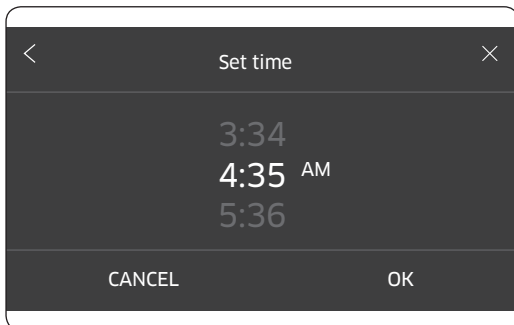

To change the time manually

The time information consists of the hour, minute, and AM/PM elements. Flick up or down to change the number, tap to select AM/PM, and then tap **SET**.

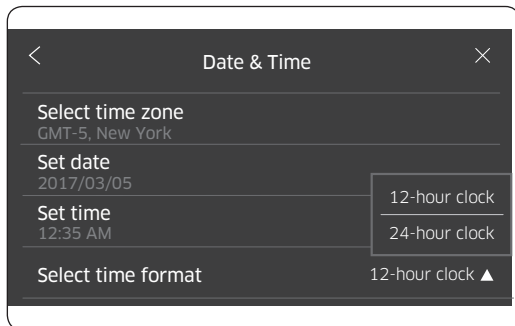

To select a time format

You can choose one from 12-hour clock and 24-hour clock. Simply tap one.

Language



Tap to select a preferred language.

Sound

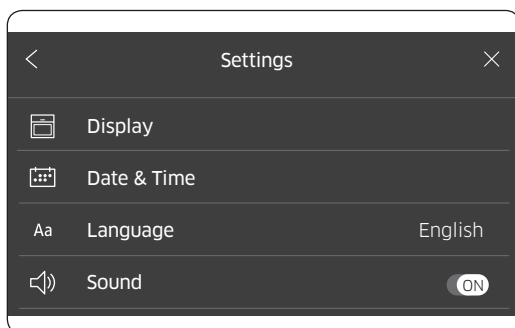

- To mute the sound from the cooktop, tap **Sound**. All sounds or melodies will be muted.
- To unmute, tap **Sound** again.

Operations

Virtual flame

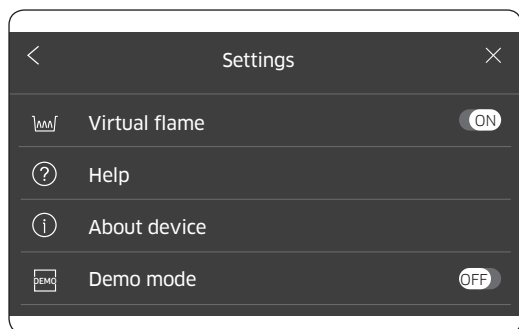

The virtual flame technology is designed to help you check the power level with the help of a visual aid. The virtual flame control at the far right is a toggle button.

- To turn the virtual flame on, tap the toggle button once. The button changes to **ON**.
- To turn it off, tap the button again. The button changes to **OFF**.

Help

This menu offers first-time use guides for troubleshooting purposes. Check this menu for your reference.

About device

Information about the device is displayed including the software version and available updates. Check this menu for your reference.

Demo mode

Before you start cooking, you can use Demo mode to simulate a cooktop operation. Demo mode will be disabled while the cooktop is operating.

Demo mode can be set approximately 1 minute after the cooktop turns on.

If you fail to set Demo mode, contact a local Dacor service center.

Special features

Virtual flame technology

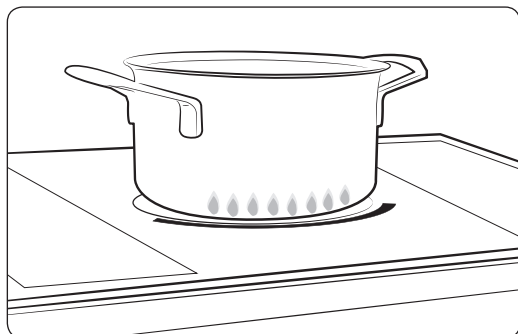

When you turn an induction burner on, the virtual flame technology creates the appearance of flames for visual references, which are not actual flames.

- The virtual flame is available only on the center burner.
- The virtual flame may look different depending on the appearance, size, and position of the cookware. For best visual results, use cookware that matches the burner size. Cookware that is too large can cover the virtual flame. Cookware that is too small can cause the virtual flame to be ill-formed.
- Impurities on the cookware bottom or the cooktop surface can cause the virtual flame to be ill-formed or incomplete.
- Clean the cookware or the cooktop surface before using them.

Recommended cookware for virtual flames

Bottom size	11 inches (260 - 280 mm)
	6 inches (135-150 mm)
Shape	Horizontal hair-line
Material	Stainless steel

Special features

Flex Zone

You can use the Flex Zone function to control two burners on the side as a single cooking zone. This is useful for larger cookware such as oval cookware, or large spaghetti pots.



1. Select a cooking zone by tapping or dragging individual burners. The selected two burners are synched and will operate as one.
2. Use a burner control to adjust the power level of the synched burners.
3. To cancel this function, tap **OFF**.

Auto pan detection

With Flex Zone enabled, the Flex Zone indicator uses an automatic cookware detection to display the active zones.

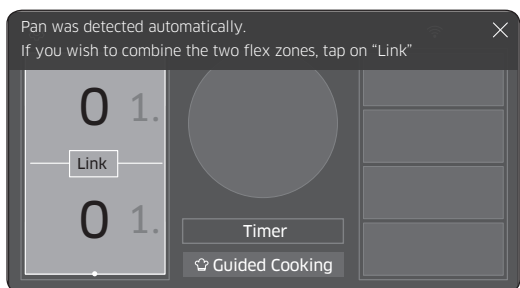

- If inappropriate cookware is placed on the cooking zone, the indicator blinks. If the cookware is not removed, the cooking zone turns off.
- Any of the synched burners may not operate properly with small cookware that slants to one burner slightly.

Flex Zone

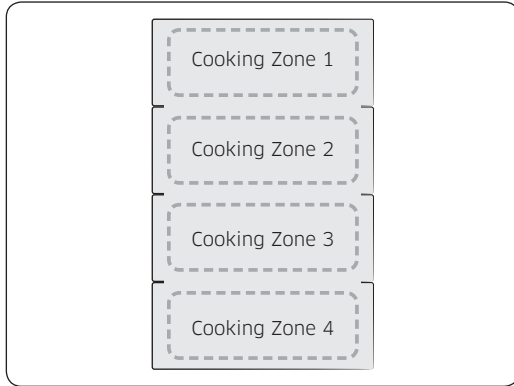

- The Flex Zone is a large cooking area located on the side of the cooktop (see the figure on the left) that is specially designed to accommodate multiple cookware of different shapes and sizes at once.
- The Flex Zone has four zones that are operated by individual inductors, allowing you to cook regardless of where cookware is placed on a cooking zone.
- With Flex Zone, you can use a combination of different cooking zones to enlarge the cooking area. See the table below for details about different combinations.

Cooking Zone	1 burner	2 burner	3 burner	4 burner
1				
2				
3				
4				

NOTE

- When using only one cooking zone, the bottom diameter of the cookware must be less than 14 cm.
- The cooktop may take 5 - 10 seconds to recognize the position of the cookware.
- Noises may occur while the cooktop recognizes the cookware.
- Do not remove cookware during cooking. For safety reasons, the cooktop automatically stops operation 5 seconds after the cookware is removed.

Special features

Power Boost

The Power Boost function provides additional power to each cooking zone. You might use this function to boil a large amount of water. When the boosting time expires, the cooking zone automatically returns to power level 9.0.

Cooking zone	Max boost time
11 inches	8 minutes
6 inches	10 minutes
Front or rear Flex Plus	10 minutes
Complete Flex Plus	5 minutes

NOTE

To protect the internal electronic components of the cooktop, Power Boost may be deactivated automatically in certain conditions.

Power management

The maximum power range of each cooking zone is limited. If you set a cooking zone over the cooking zone's limit by turning the Power Boost on, the power management system automatically reduces the power setting of the cooking zone.

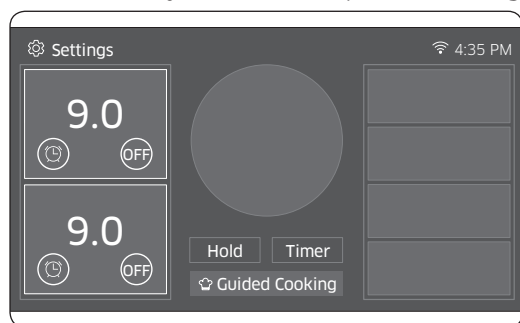

The indicator of the paired cooking zones alternates for some seconds between the set power setting and the maximum power setting. Then, the power level changes from the set power setting to the maximum power setting.

NOTE

The Power Boost function cannot be activated for all burners at the same time.

36" cooktop

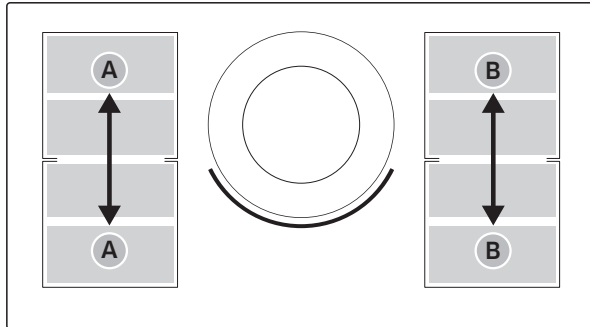

30" cooktop

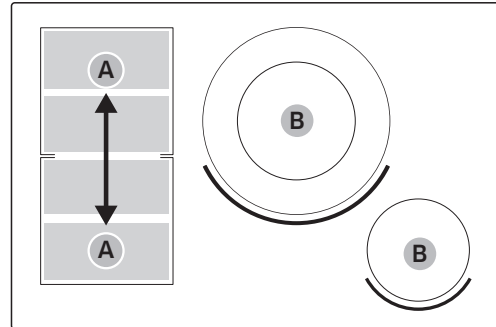

- A. Paired cooking zone
- B. Paired cooking zone

Child Lock

To prevent accidents by children or unintentional operations, all controls on the control panel will be disabled except for the **POWER** and **LOCK** buttons.

- To activate Child Lock, press and hold **LOCK** for 3 seconds. The Child Lock indicator appears.
- To deactivate Child Lock, press and hold **LOCK** again for 3 seconds. The Child Lock indicator disappears.
- To activate Child Lock while the cooktop is operating, first turn the cooktop off. This is for your safety.
- If Child Lock is activated when the cooktop is not operating, all buttons will be disabled except for the **POWER** and **LOCK** buttons.
- If you want to turn the cooktop off, simply press **POWER**.

Temperature detection

If for any reason the temperatures on any of the cooking zones exceed the safety level, the cooking zone will then automatically reduce the heat to a lower power level.

When you have finished using the cooktop, the cooling fan will continue to run until the cooktop's electronics have cooled down. The cooling fan switches itself on and off depending upon the temperature of the electronics.

Maintenance

Cleaning

CAUTION

- Do not use scrub pads other than those recommended. The glass surface may be scratched or damaged.
- Do not allow spills to remain on the cooking area or the cooktop trim for a long period of time.
- Do not use abrasive cleansing powders or scouring pads, which will scratch the cooktop.
- Do not use chlorine bleach, ammonia, or other cleansers not specifically recommended for use on a glass-ceramic surface.

First-time cleaning

1. Before using the cooktop for the first time, clean it with a ceramic cooktop cleaner.
2. Shake the cleaner well. Apply a few drops of cleaner directly to the cooktop surface.
3. Use a paper towel or a cleaning pad for ceramic cooktops to clean the entire cooktop surface.
4. Use a dry cloth or paper towel to remove all cleaning residue. Rinsing is not necessary.

NOTE

- Use only a ceramic cooktop cleaner. Other cleaners may not be as effective.
- Clean the cooktop before using it for the first time.
- Clean your cooktop daily or after each use. This will keep your cooktop clean and can prevent damage.
- If a spillover occurs while you are cooking, immediately clean the spill while it is hot to prevent difficult cleaning later. Using extreme care, wipe the spill with a clean, dry towel.

Cooktop surface

To remove burned residue

1. Allow the cooktop to cool down.
2. Apply a few drops of ceramic cooktop cleaner on the entire burned residue area.
3. Use a cleaning pad for ceramic cooktops to rub the burned area as hard as necessary until no residue remains.
4. For additional protection, use a paper towel with a ceramic cooktop cleaner to polish the entire surface.

To remove stubborn impurities

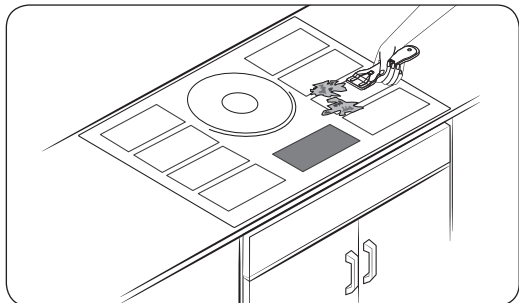

1. Allow the cooktop to cool down.
2. Use a single-edge razor-blade scraper at approximately a 45° angle against the glass surface and scrape the impurities. You must apply pressure to remove the residue.
3. After scraping with the razor scraper, apply a few drops of ceramic cooktop cleaner on the entire area. Use a cleaning pad to remove any remaining residue. Do not scrape the seal around the edges of the cooktop.
4. For additional protection, use a paper towel with a ceramic cooktop cleaner to polish the entire surface.

To remove metal marks and scratches

- Use caution not to slide cookware across your cooktop. It will leave marks on the cooktop surface. You can remove these marks by applying ceramic cooktop cleaner and using a cleaning pad for ceramic cooktops.
- If cookware with a thin overlay of aluminum or copper boil dry, the overlay may leave black discolorations on the cooktop. Remove the discolorations immediately, or they may become permanent.

CAUTION

Carefully check the bottoms of cookware for roughness that may scratch the cooktop.

Maintenance

To remove sugary spills and melted plastic

Sugary spillovers (such as jellies, fudge, candy, syrups) or melted plastics can produce pitting on the surface of your cooktop. This is not covered under the Warranty. You must clean the spills while they are still hot. Use caution when removing hot substances.

1. Turn all burners off. Remove any hot cookware.
2. Wear an oven mitt, and then use a single-edge razor-blade scraper to move the spills to a cool area of the cooktop. Remove the spills with paper towels.

CAUTION

- Any remaining spillover must remain until the surface of the cooktop has cooled down.
- Do not use the burners again until all the spills have been completely removed.
- When using a scraper, be sure it is new and the razor blade is sharp. Do not use a dull or nicked blade.

NOTE

If there are pitting or indentations in the glass surface, the cooktop glass must be replaced. If this is the case, call for service.

Surface protection

To prevent unintended marks and scratches

- Do not use glass cookware. It may scratch the cooktop.
- Do not place a trivet or wok ring between the cooktop and a pan or wok. These items can mark or scratch the cooktop.
- Make sure the cooktop and the cookware bottom are clean.
- Do not slide metal cookware across the cooktop.

To prevent stains from building up

- Do not use a soiled dish cloth or sponge to clean the cooktop surface. A film will remain, which may cause stains on the cooking surface after the area is heated.
- Continuously cooking on a soiled surface can result in permanent stains.

To prevent damage to the cooktop

- Do not allow plastic, sugar, or foods with high sugar content to melt onto a hot cooktop. If this happens, clean immediately.
- Do not let cookware boil dry as this will damage the cooktop and the cookware.
- Do not use the cooktop as a work surface or cutting board.
- Do not cook food directly on the cooktop. Always use proper cookware.

Cooktop sealing

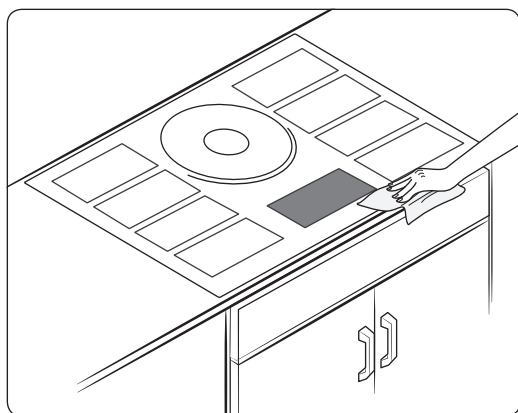

To clean the sealing around the edges of the glass, put a wet cloth on it for a few minutes, and then wipe clean with a nonabrasive cleaner.

Troubleshooting

Operating noises

You may hear the following operational noises:

- **Cracking noises:** You may hear a cracking noise when you are using cookware made of two or more materials.
- **Whistling:** A whistling noise occurs when both back burners are in use. This is caused by vibrations. Whistling can vary depending on the weight or material of the cookware or the type of food you are cooking. The noise can be reduced by using thicker cookware.
- **Humming:** You may hear a low humming noise when you set a burner to a high power setting. This sound is generated by energy transmission, and it will disappear when the cooktop is turned off.
- **Clicking:** Electric switches are operating.
- **Hissing, buzzing:** You may hear a fan noise during cooktop operation. You may continue to hear it even after the cooktop is turned off. This is normal. The fan runs to cool down the temperature inside the cooktop. It will automatically shut itself off after a short period of time.

These noises are normal and do not indicate any defects.

Checkpoints

If you encounter an issue to check with your cooktop, first check the table below and try the suggestions.

Symptom	Possible cause	Solution
The burners heat up slowly or cannot maintain a rolling boil.	You may be using incorrect cookware.	Place the cookware in the center of the cooking zone. Use cookware with ferromagnetic bottoms whose diameter is appropriate for the cooking zone. See the Cookware section on page 28.
The cooktop will not turn on.	There is a blown fuse or tripped circuit breaker.	Replace the fuse or reset the circuit breaker.
	The LCD is booting.	It takes approximately 1 minute for the LCD to boot.
The burners do not turn on.	There is a blown fuse or tripped circuit breaker.	Replace the fuse or reset the circuit breaker.
	The cooktop controls are not set correctly.	Make sure the controls are set correctly for the respective surface unit.

Symptom	Possible cause	Solution
The cooktop has stains or discoloration.	Food spills/stains were not cleaned.	See the Cleaning section on page 56.
	The cooktop is hot.	The cooktop may appear discolored if it is hot. This is temporary, and the discoloration will disappear as the cooktop cools.
The cooktop has scratches or abrasions.	The cooktop is not being correctly cleaned.	Scratches cannot be removed. However, tiny scratches will become less visible with cleaning. Use glass-ceramic cleaning cream. Do not use chemical or corrosive agents. These agents may damage the cooktop.
	Cookware with rough bottoms were used. There were coarse particles such as salt between the cookware and cooktop.	To avoid scratches, follow the recommended cleaning instructions. Before using, make sure cookware bottoms are clean. Only use smooth, flat-bottomed cookware.
	Cookware may have slid across the cooktop.	
The cooktop has streaks or specks.	Spillovers have cooked onto the cooktop.	Wait until the cooktop is cool. Use a single-edge razor-blade scraper to remove the streaks or specks. For more information, see the Cleaning section on page 56.
The cooktop has metallic discolorations.	Mineral deposits from water and food have stained the cooktop.	To remove the stains, use a glass-ceramic cooktop cleaning cream. For best results and care, clean the cooktop weekly. Only use clean, dry cookware.
The cookware is not detected.	Inappropriate cookware was used, or the cookware is not placed on the cooking zone.	Place the cookware in the center of the cooking zone. Use cookware with ferromagnetic bottoms whose diameter is appropriate for the cooking zone. See the Cookware section on page 28.

Troubleshooting

Symptom	Possible cause	Solution
The boost function has been deactivated or cannot be activated.	A cooking position is already paired, and the cooktop is too hot.	You can activate the boost function only once for a single burner. If a second cooking position is switched on or is already in operation, the boost function will not be available or is deactivated, and the cooking position returns to power level 9.0. The cooktop may be hot. Wait until the cooktop cools down.
The cooktop responds unusually or can no longer be operated correctly.		Disconnect the appliance from the electric supply by switching the circuit breaker off to the off position for 15 seconds.
There are cracking or popping sounds.	The power level is set between 1.0 and 3.0. And two pots are put on the Flex Zone.	This is normal. The strength of sound depends on the number and the size of the pots.
There are beeping sounds.	Occurs if buttons are repeatedly pressed.	Cookware is on the touch buttons, and hot cookware can damage the buttons. Remove the cookware.

Information codes

Code	Possible cause	Solution
C0	The top sensor is open.	Turn the cooktop off, and then restart. If the issue continues, unplug the power cord for 30 seconds or more, and then reconnect. If the issue is not resolved, contact a Dacor service center.
C1	The top sensor is short.	
C2	The IGBT sensor is open.	
F0	Communications between the main and the sub PCBs failed.	Restart the cooktop using the POWER button. If the issue continues, disconnect power for more than 30 seconds. Then, restart the cooktop. If the issue is not resolved, contact a Dacor service center.
F1	Communications with EEPROM failed.	
F2	Communications with the touch-enabled IC failed.	
A2	The fan motor malfunctions.	It occurs when the DC motor can not operate due to defects of the PCB, wiring or blockage on the motor blade.
UP	The input voltage is too high or low.	Check the power connection and make sure to turn the cooktop on after regulating the voltage (208 V to 240 V).
d0	The key is pressed for more than 8 seconds.	Check if the key pad is wet or a key is depressed. If the problem continues, restart the appliance using the POWER button. If the problem still continues, contact a local Dacor service center.

Warranty and Service

Warranty

Review this section to learn the warranty and non-warranty terms and conditions concerning this product. For details/clarifications, contact Dacor.

What Is Covered—Certificate of Warranties: Dacor Cooktops	
Within the 50 States of the USA, District of Columbia, and Canada*	
Full 1-Year Warranty	<p>The warranty applies only to the Dacor appliance sold to the first-use purchaser, starting from the date of original retail purchase or closing date for new construction, whichever period is longer. The warranty is valid on products purchased brand new from a Dacor Authorized Dealer or other Dacor authorized seller.</p> <p>If your Dacor product fails to function within one year of the original date of purchase due to a defect in material or workmanship, Dacor will remedy it without charging you.</p> <p>All cosmetic damage (e.g., scratches on stainless steel, paint/porcelain blemishes, etc.) to the product or included accessories must be reported to Dacor within 60 days of the original purchase date to qualify for warranty coverage.</p>
Coverage Limitations	<p>Service will be provided by a Dacor-designated service company during regular business hours. (Service providers are independent entities and are not agents of Dacor.)</p> <p>These types of products carry a one-year parts warranty only:</p> <ul style="list-style-type: none"> • Dealer-display and model-home-display products with a production date greater than 5 years • Products sold “As Is” • Products installed for non-residential use (e.g., religious organizations, fire stations, bed and breakfast, spas, etc). <p>All delivery, installation, labor costs, and other service fees are the purchaser’s responsibility.</p> <p>The warrant is null and void if the product’s serial numbers and/or tags are altered/defaced/missing.</p> <p>The owner must provide proof of purchase or a closing statement for new construction upon request.</p> <p>All Dacor products must be accessible for service.</p>

Outside the 50 States of the USA, District of Columbia, and Canada*	
Limited 1st-Year Warranty	<p>If your Dacor product fails to function within one year of the original date of purchase due to a defect in material or workmanship, Dacor will furnish a new part, FOB Factory**, to replace the defective part.</p> <p>All delivery, installation, labor costs, and other service fees are the buyer's responsibility.</p>
What Is Not Covered	
<ul style="list-style-type: none"> • Slight color variations (due to differences in painted parts, kitchen lighting, product placement, etc) • Service calls (to teach the user proper use and care of the product) • Travel fees to islands/remote areas (ferries, toll roads, etc) • Consequential/incidental damage (food/medicine loss, time away from work, restaurant meals, etc) • Product failure (when product is used for commercial, business, rental, or any application other than residential use) • Product failure (caused by improper product installation) • Replacement of house fuses, fuse boxes, or resetting of circuit breakers) • Product damage (caused by accident, fire, flood, power interruption, power surges, or other "acts of God") • Liability or responsibility for damage to surrounding property (cabinetry, floors, ceilings, and other structures/objects) • Breakage, discoloration, or damage to glass, metal surfaces, plastic parts, trim, paint, or other cosmetic finish from improper use/abuse/care/neglect • Consumable parts (e.g., filters, light bulbs). 	

Warranty and Service

Out of Warranty

Contact us if you experience a service issue beyond the standard warranty period. Dacor reviews each issue and customer concern to provide the best possible solution under the circumstances.

THE REMEDIES PROVIDED IN THE ABOVE EXPRESS WARRANTIES ARE THE SOLE AND EXCLUSIVE REMEDIES; THEREFORE, NO OTHER EXPRESS WARRANTIES ARE MADE, AND OUTSIDE THE FIFTY STATES OF THE UNITED STATES, THE DISTRICT OF COLUMBIA AND CANADA, ALL IMPLIED WARRANTIES, INCLUDING BUT NOT LIMITED TO, ANY IMPLIED WARRANTY OF MERCHANTABILITY OR FITNESS FOR A PARTICULAR USE OR PURPOSE, ARE LIMITED IN DURATION TO ONE YEAR FROM THE DATE OF ORIGINAL PURCHASE. IN NO EVENT SHALL DACOR BE LIABLE FOR INCIDENTAL EXPENSE OR CONSEQUENTIAL DAMAGES. IN THE EVENT DACOR PREVAILS IN ANY LAWSUIT, DACOR SHALL BE ENTITLED TO REIMBURSEMENT OF ALL COSTS AND EXPENSES, INCLUDING ATTORNEY'S FEES, FROM THE DACOR CUSTOMER. NO WARRANTIES, EXPRESS OR IMPLIED, ARE MADE TO ANY BUYER FOR RESALE.

Some states do not limit the length of an implied warranty, or do not exclude/limit inconsequential damages; therefore, the above exclusions/limitations may not apply to you. This warranty gives you specific legal rights. You may also have other/additional rights depending on the state in which you reside.



Please visit www.Dacor.com to activate your warranty online.

WARRANTY INFORMATION



IMPORTANT:

Your warranty will not begin until you activate it online or return this form to Dacor. If you have purchased more than one Dacor product, please return all forms in one envelope, or activate the warranty for each product online.

Please rest assured that under no conditions will Dacor sell your name or any of the information on this form for mailing list purposes. We are very grateful that you have chosen Dacor products for your home and we do not consider the sale of such information to be a proper way of expressing our gratitude!

Owner's Name:

Street: _____
Last (Please Print or Type) First Middle

City: _____ State: _____ Zip: _____

Purchase Date: _____ Email: _____ Telephone: _____

Dealer: _____

City: _____ State: _____ Zip: _____

Your willingness to take a few seconds to fill in the section below will be sincerely appreciated. Thank you.

1. How were you first exposed to Dacor products? (Please check one only.)

- A. T.V. Cooking Show
- B. Magazine
- C. Appliance Dealer Showroom
- D. Kitchen Dealer Showroom
- E. Home Show
- F. Builder
- G. Architect/Designer
- H. Another Dacor Owner
- I. Model Home
- J. Other _____

2. Where did you buy your Dacor appliances?

- A. Appliance Dealer
- B. Kitchen Dealer
- C. Builder Supplier
- D. Builder
- E. Other _____

3. For what purpose was the product purchased?

- A. Replacement *only*
- B. Part of a Remodel
- C. New Home
- E. Other _____

4. What is your household income?

- A. Under \$75,000
- B. \$75,000 - \$100,000
- C. \$100,000 - \$150,000
- D. \$150,000 - \$200,000
- E. \$200,000 - \$250,000
- F. Over \$250,000

5. What are the brands of appliances that you have in your kitchen?

- A. Cooktop _____
- B. Oven _____
- C. Dishwasher _____
- D. Refrigerator _____

6. Would you buy or recommend another Dacor product?

- Yes
- No

Comments: _____

Thank you very much for your assistance. The information you have provided will be extremely valuable in helping us plan for the future and giving you the support you deserve.

Place Serial Number Label Here

Website: www.Dacor.com

Phone: (800) 793-0093

cut here

cut here



NO POSTAGE
NECESSARY
IF MAILED
IN THE
UNITED STATES

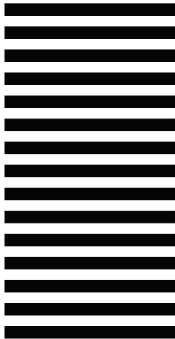

BUSINESS REPLY MAIL
FIRST-CLASS MAIL PERMIT NO 1600 CITY OF INDUSTRY CA

POSTAGE WILL BE PAID BY ADDRESSEE

DACOR
ATTN: WARRANTY PROCESSING DEPT
PO BOX 90070
CITY OF INDUSTRY, CA 91715-9907



fold here



DG68-00899A-00



Dacor • 14425 Clark Avenue, City of Industry, CA 91745 • Phone: (800) 793-0093 • Fax: (626) 403-3130 • www.dacor.com