

5

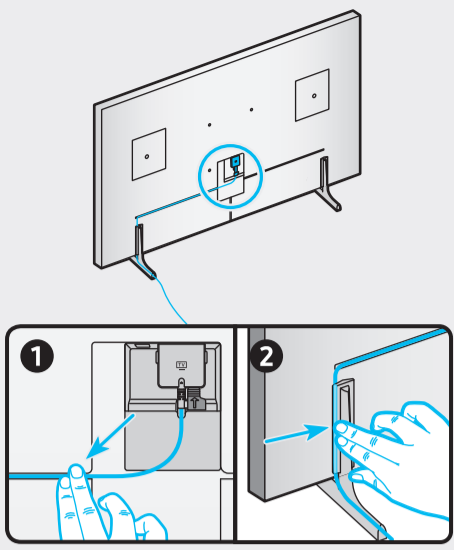

6

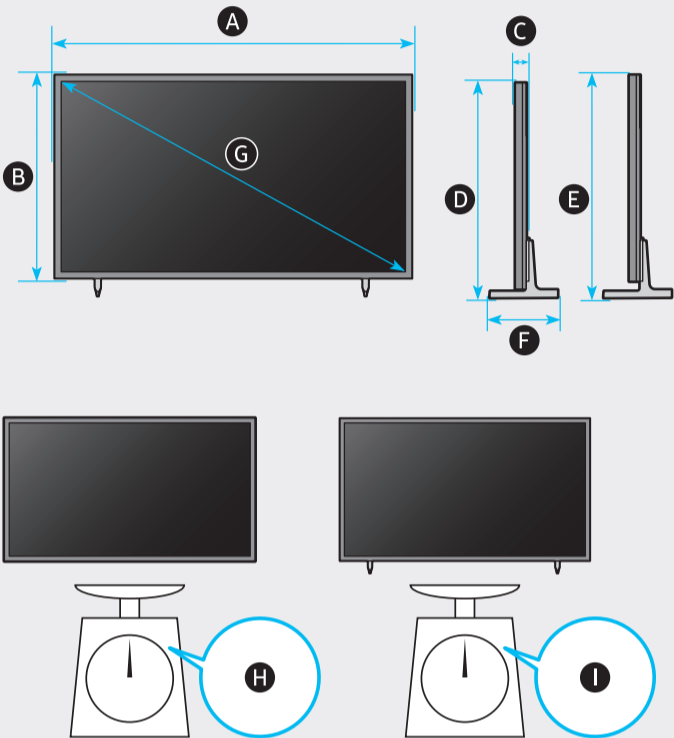
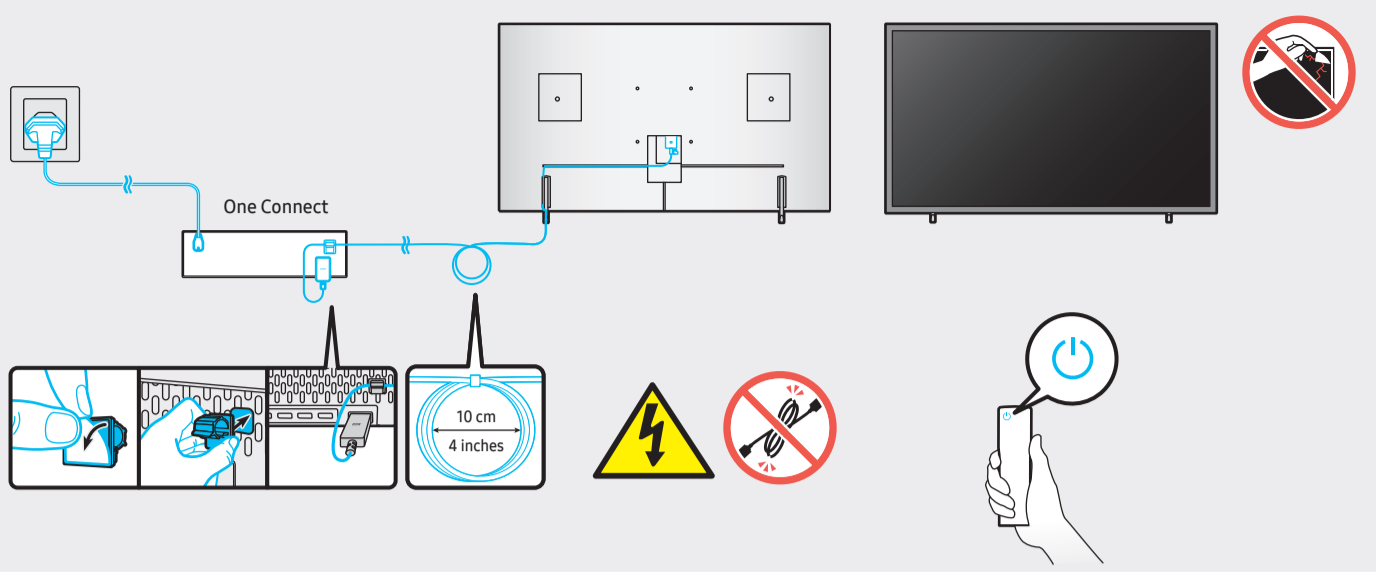

	A	B	C	D	E	F	G	H	I
QN55LS03B	48.7 inches (1237.9 mm)	27.9 inches (708.8 mm)	1.0 inches (24.9 mm)	29.3 inches (743.4 mm)	30.3 inches (768.4 mm)	9.0 inches (227.8 mm)	54.6 inches	37.3 lbs (16.9 kg)	38.1 lbs (17.3 kg)
QN65LS03B	57.4 inches (1456.8 mm)	32.8 inches (831.9 mm)	1.0 inches (24.9 mm)	34.2 inches (868.9 mm)	35.2 inches (893.9 mm)	10.3 inches (260.9 mm)	64.5 inches	49.4 lbs (22.4 kg)	50.3 lbs (22.8 kg)

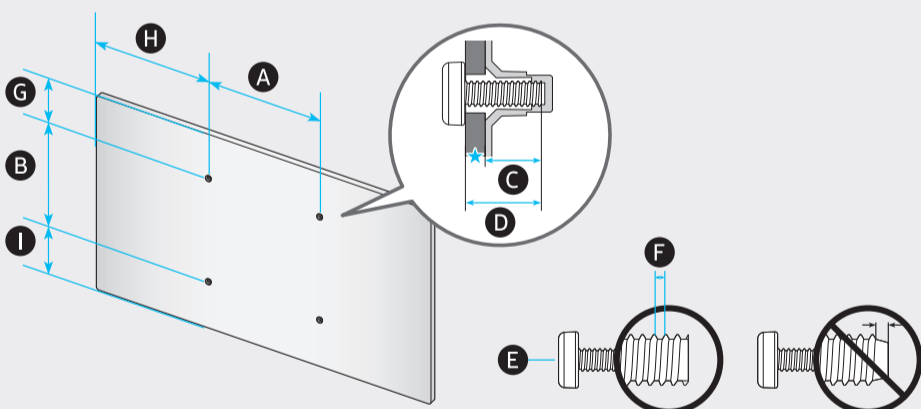

	VESA A x B (mm)	C (mm)	D	E x 4	F (mm)	G (inches)	H (inches)	I (inches)
QN55LS03B	200 x 200	10-12	C + ★	M8	1.25	9.5	20.4	10.5
QN65LS03B	400 x 300					10.5	20.8	10.4

★ : Wall-Mount Bracket

SAMSUNG

QUICK SETUP GUIDE



◀ Scan this QR code with your smart phone to see helpful videos.

55"

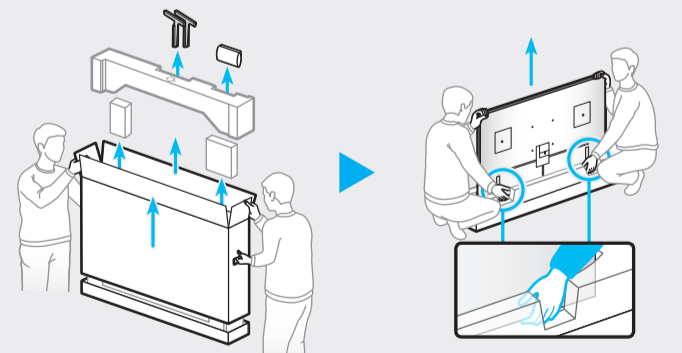

65"

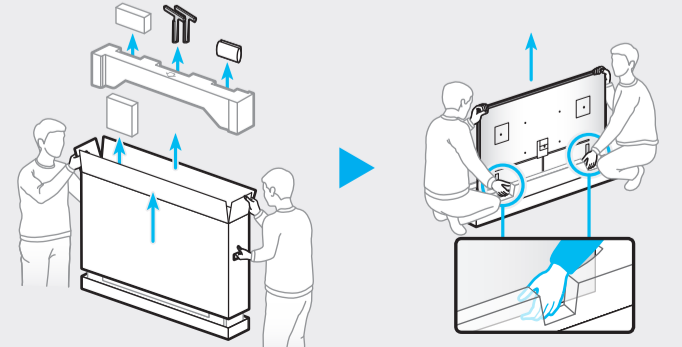

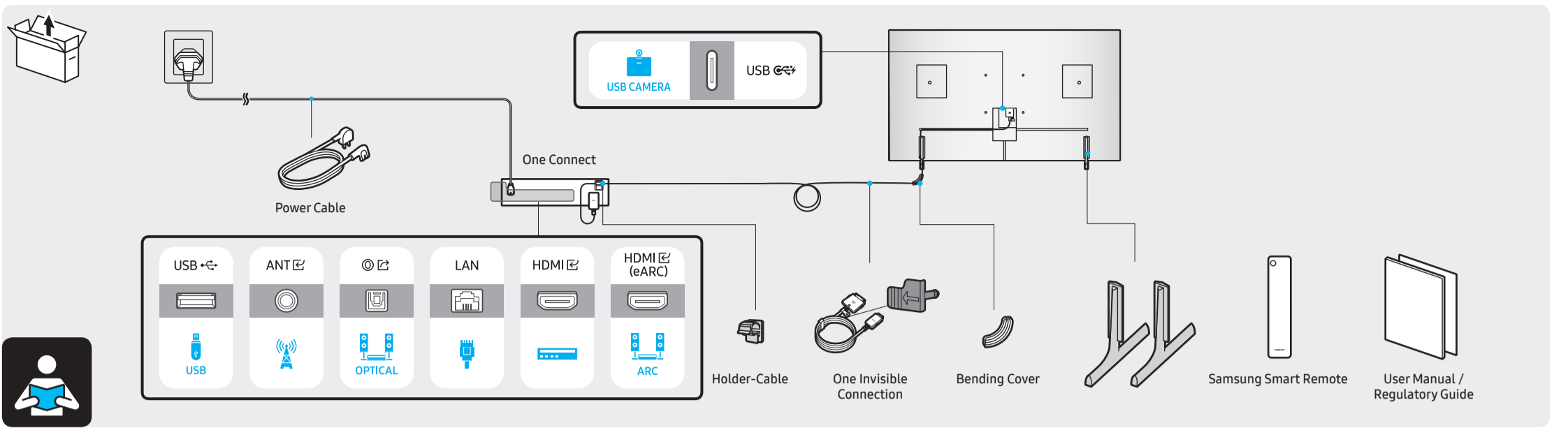

1

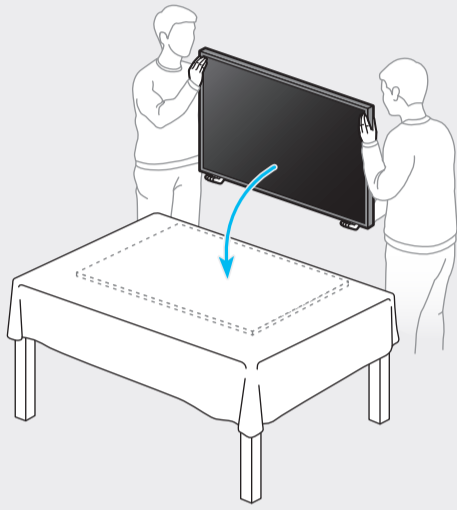

2

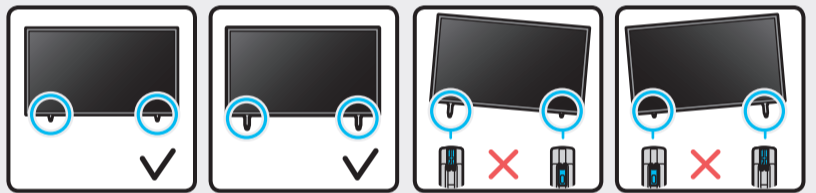
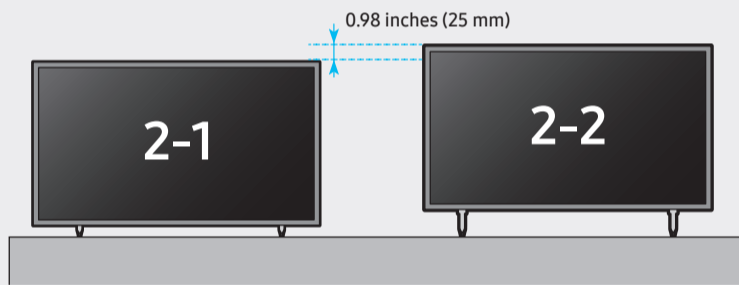
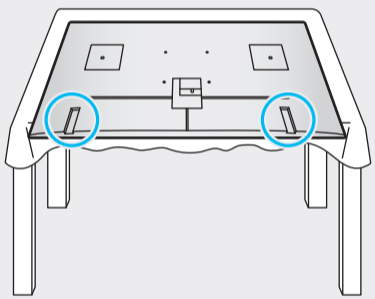

2-1

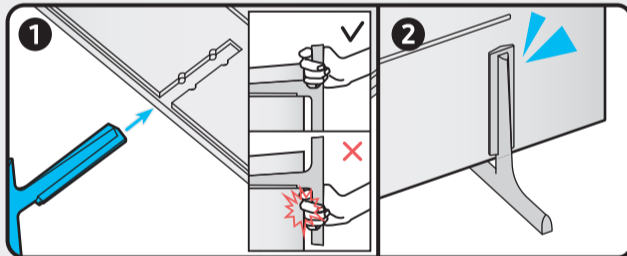
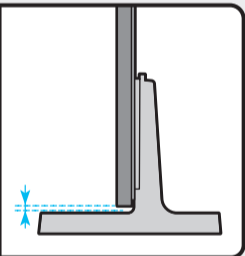
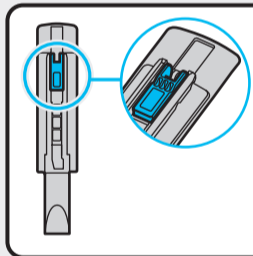
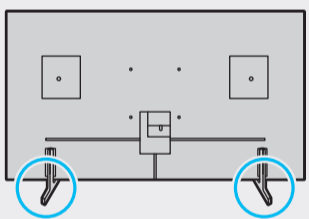

2-2

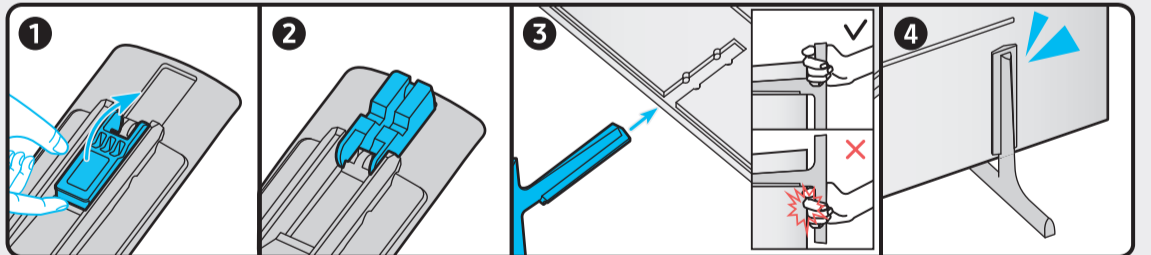
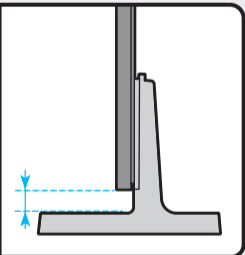
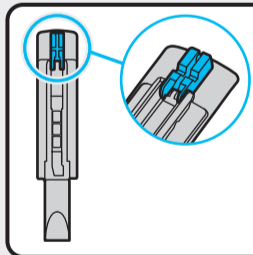
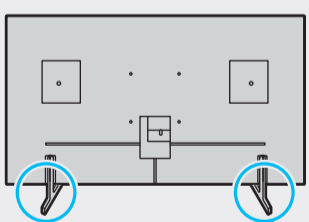

3

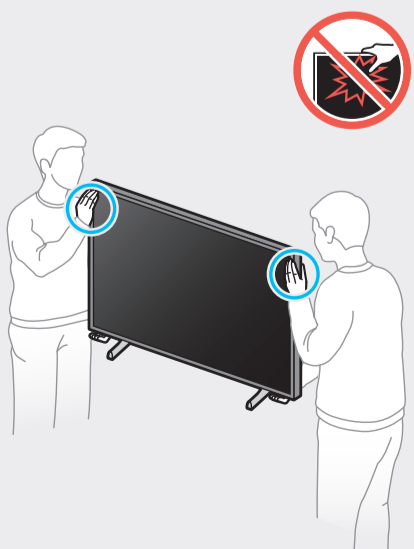

4

