

S90C

***Dimensions in millimeters (+ / - 0.1 mm)**

S90C Set Dimension

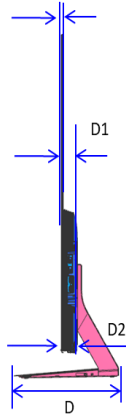

* D1: Excludes LOGO (Representative Dimension)
* D2: Includes LOGO

	55"	65"	77"
SET(With stand) (W * H * D)	1225.4 * 773.5 * 265.9	1444.3 * 896.6 * 265.9	1718.5 * 1058.9 * 359.8
SET(Without stand) (W * H2(H1) * D1(D2))	1225.4 * 708.6(703.2) * 39.9(41.0)	1444.3 * 831.7(826.4) * 39.9(41.0)	1718.5 * 987.6(981.6) * 44.9(45.9)
Front Opening Area (A * B * C)	1221.7 * 690.9 * 1403.5	1440.6 * 814.0 * 1654.7	1713.6 * 968.5 * 1968.4
Wall Mount (a * b)	300.0 * 200.0	300.0 * 200.0	400.0 * 300.0
Packing Out (W * H * D)	1385 * 833 * 153	1617 * 950 * 160	1890 * 1182 * 192
Net Weight (With stand) Kg	18.2	23.1	37.8
Net Weight (Without stand) Kg	16.2	21.1	35.1
Gross Weight Kg	24.4	30.9	49.1

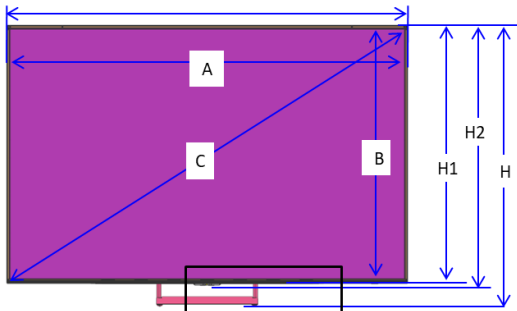

* H1 : CHASSIS FRONT BOTTOM
* H2 : Outermost of FUNCTION
(Representative Dimension)
* H : Includes Rubber-Foot

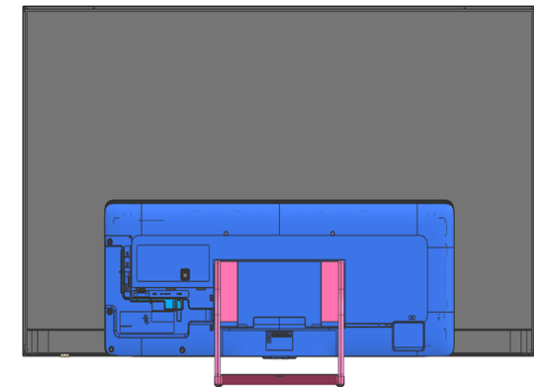
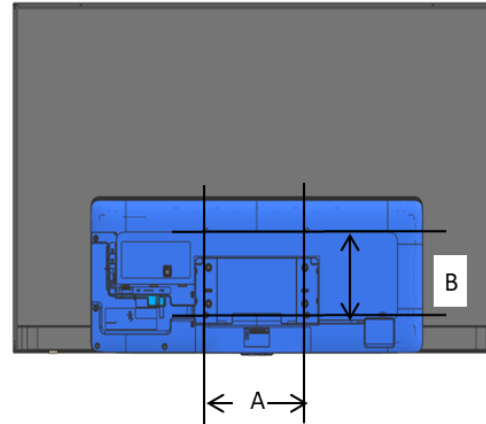
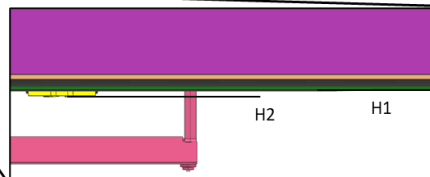

**Dimensions in millimeters (+ / - 0.1 mm)*

S90C Cover and Rear-View Dimensions

	55"	65"	77"
WALL MOUNT(A*B)	300 * 200	300 * 200	400 * 300
C	342.0	342.0	490.1
D	79.5	79.5	70.4
E	95.7	95.7	78.5
X	462.7	572.1	658.5
Y	412.9	536.0	609.1
Screw Depth	28~30	28~30	28~30

※ C,D
Outermost of COVER-REAR

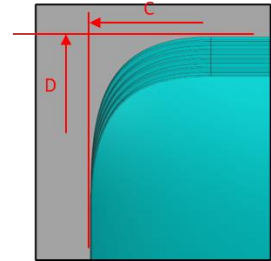

※ X,Y
Outermost of SET (Chassis-Front)

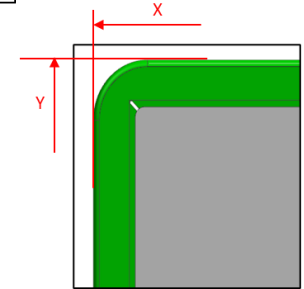

※ E
Outermost of FUNCTION

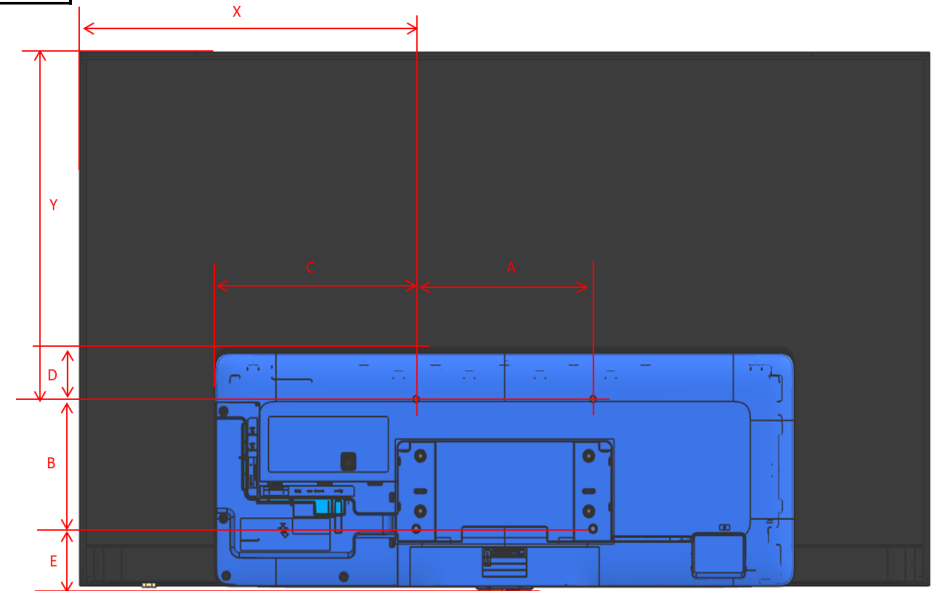
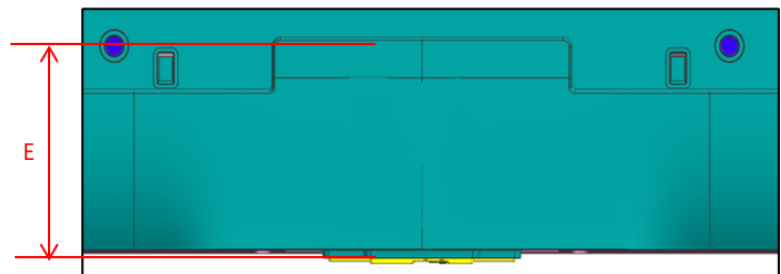

S90C

**Dimensions in millimeters (+ / - 0.1 mm)*

S90C 55" Cover and Rear-View Dimensions

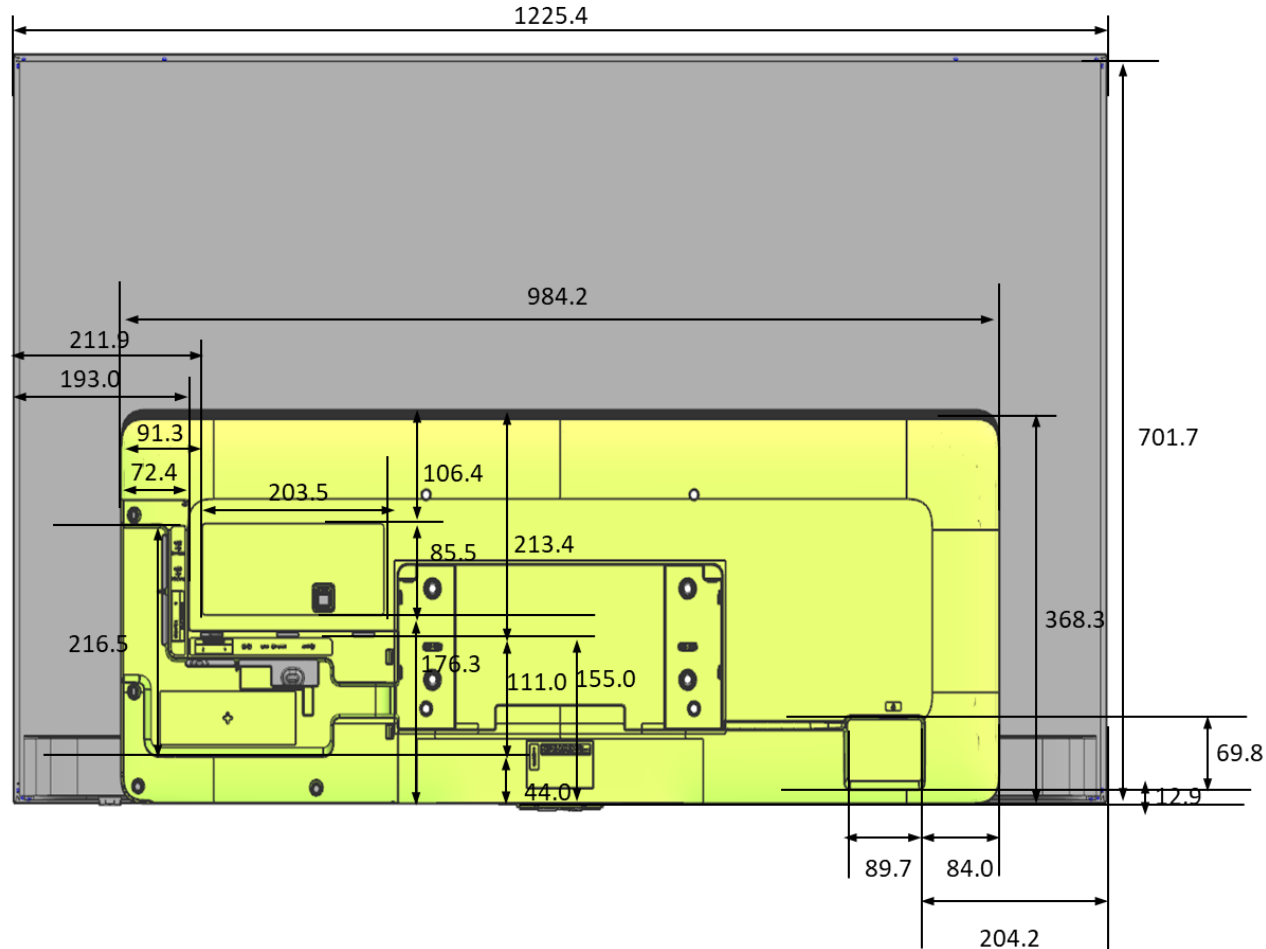

S90C

**Dimensions in millimeters (+ / - 0.1 mm)*

S90C 65" Cover and Rear-View Dimensions

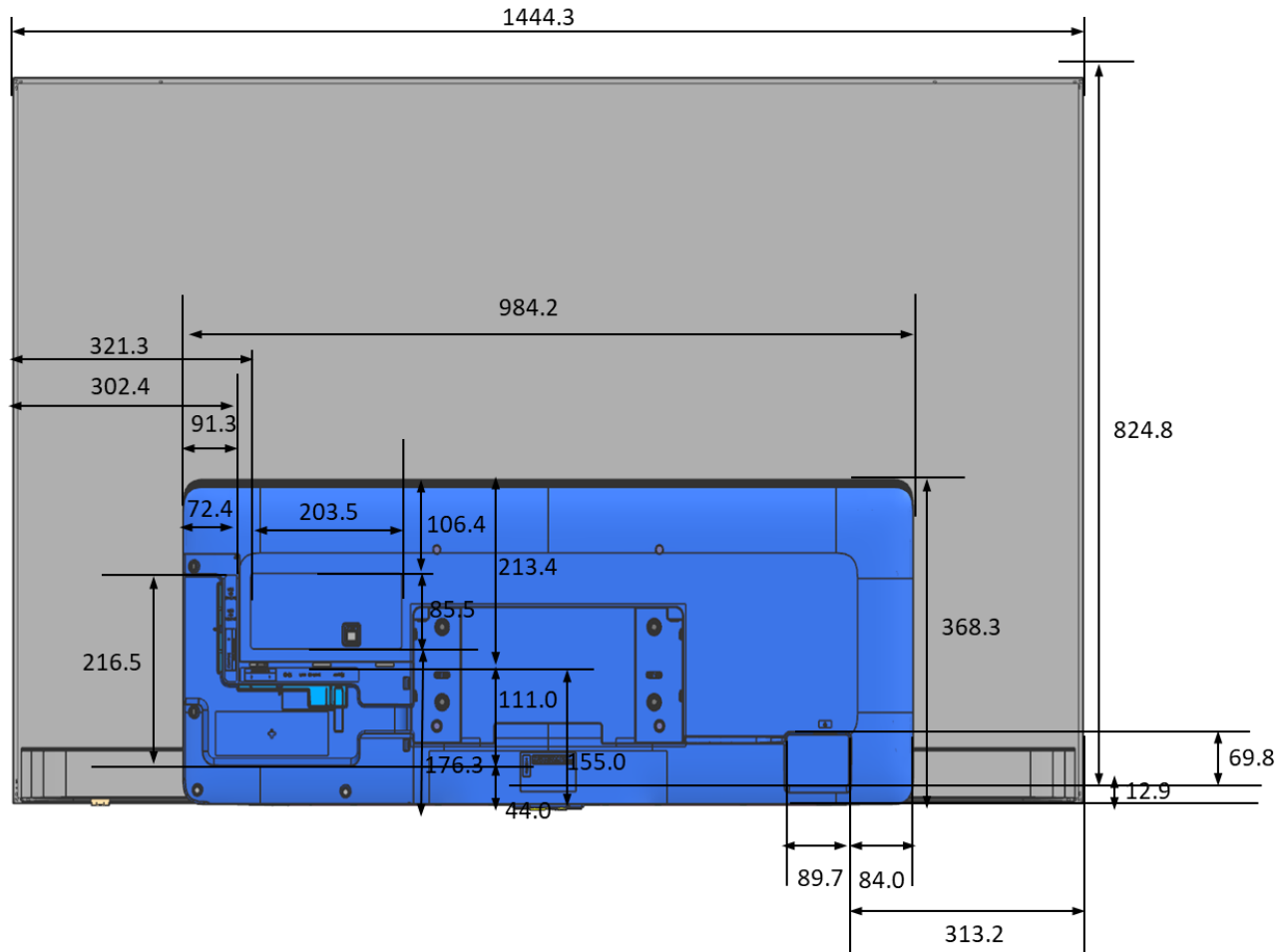

**Dimensions in millimeters (+ / - 0.1 mm)*

S90C 77" Cover and Rear-View Dimensions

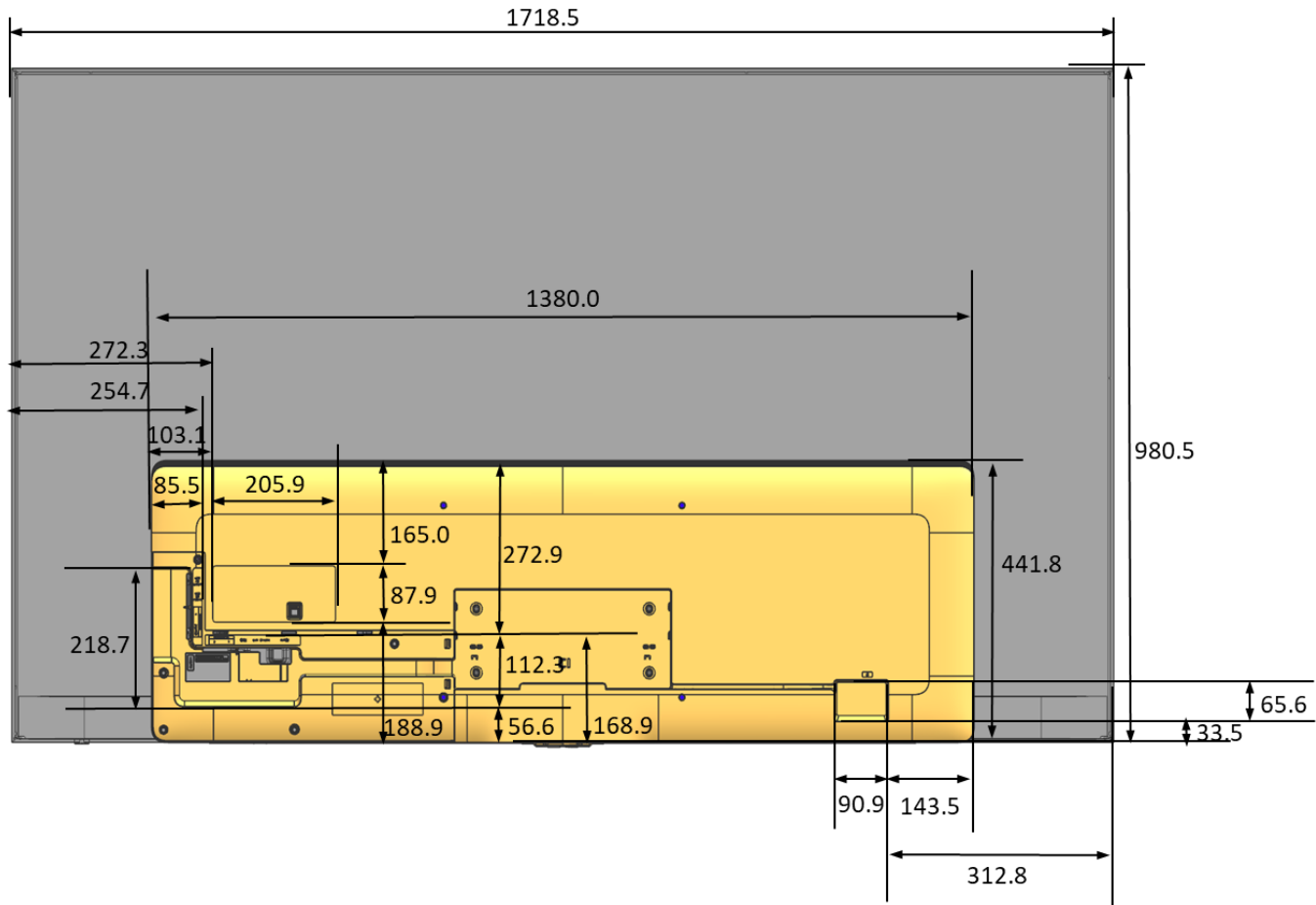

S90C

**Dimensions in millimeters (+ / - 0.1 mm)*

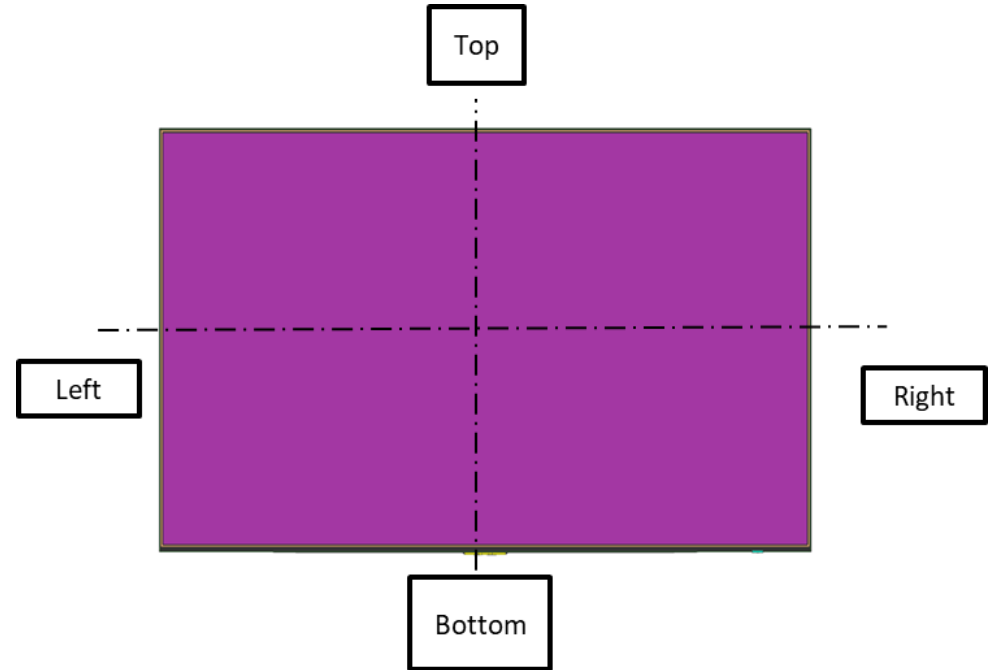
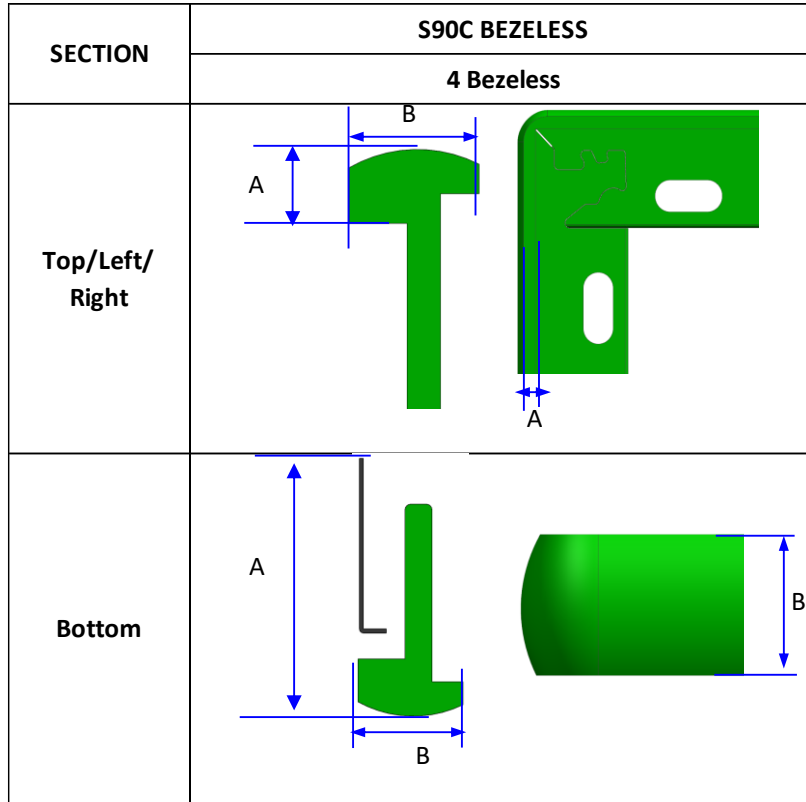

S95C Bezel Dimensions

	55"		65"		77"	
	T/L/R	Bottom	T/L/R	Bottom	T/L/R	Bottom
A	1.85	9.00	1.85	9.00	2.50	9.60
B	3.89	3.89	3.89	3.89	6.95	6.95

S90C

**Dimensions in millimeters (+ / - 0.1 mm)*

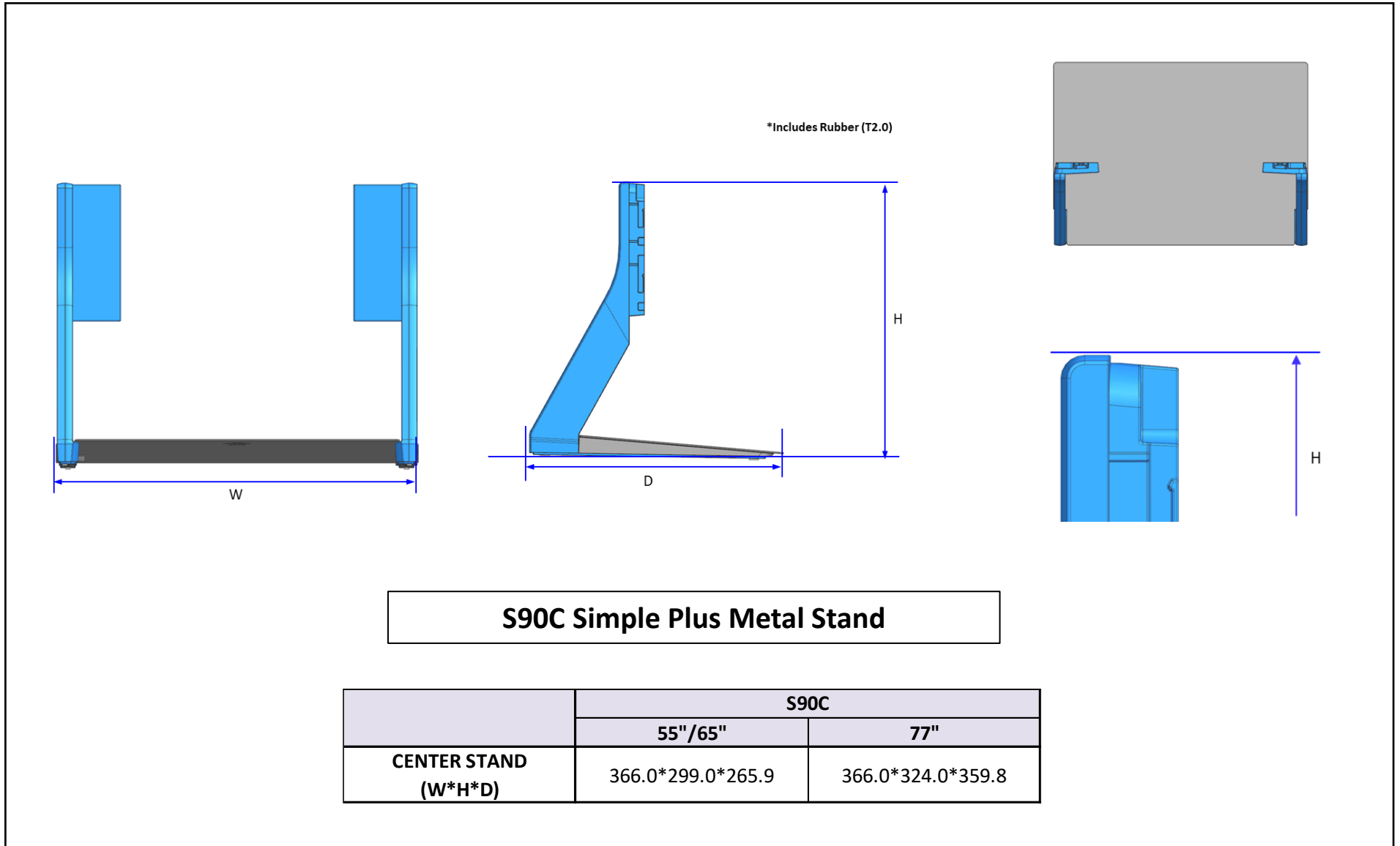

**Dimensions in millimeters (+ / - 0.1 mm)*

2023 New Model IR Sensor Information

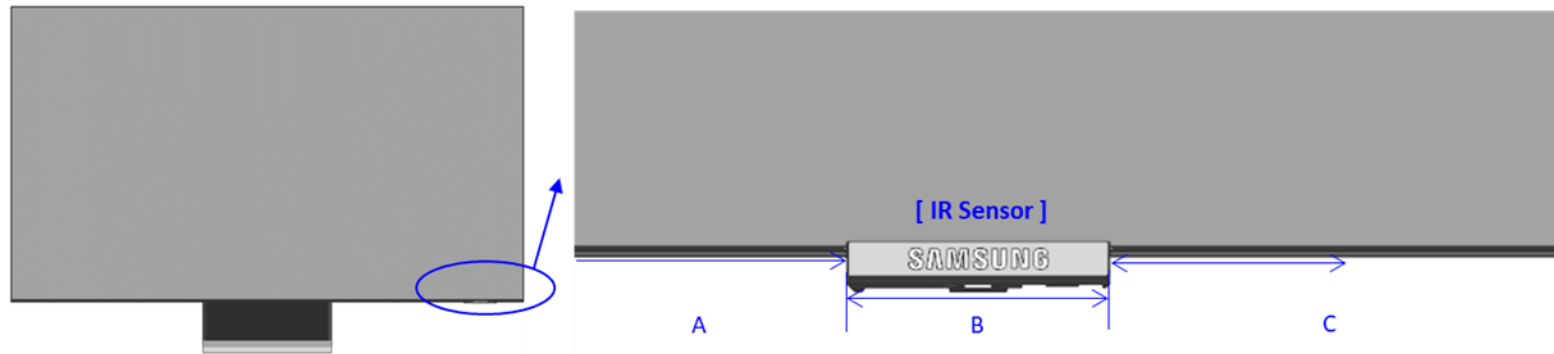

Product	Series	Inch	Item	Sensor Position	DIMENSION		
					A	B	C
OLED	S90C	77	QN77S90CAFXZA	Center	816	91.4	816
		65	QN65S90CAFXZA	Center	676.4	91.4	676.4
		55	QN55S90CAFXZA	Center	567	91.4	567